

# loun- ge sca- pe

price list 2022



poltroncina  
armchair



packaging 9 pz - 93x58x235 cm - 1,30 mc

360







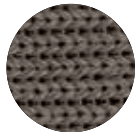
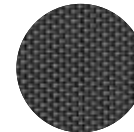

- struttura in alluminio verniciato a polveri
- resistente alle intemperie e alla luce solare (UV)
- corda in gomma con rivestimento in textilene-olefin
- cuscino 10 cm con rivestimento textilene gomma quick dry foam densità 30
- piano tavolo in lamiera - struttura in alluminio
- impilabile

- aluminium frame powder coating
- weatherproof and sunlight resistant (UV) structure
- rope with rubber inside textilene-olefin outside
- cushion 10 cm textilene cover quick dry foam 30 density
- sheet metal table top - aluminum structure
- stackable

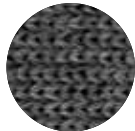
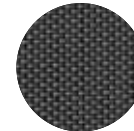

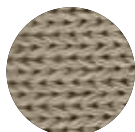
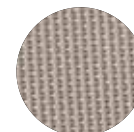
drop set è composto da:  
2 poltrone, 1 divano e 1 tavolino.  
La vendita separata dei singoli elementi non è consentita.

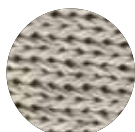
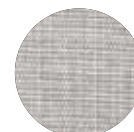
drop set is composed by:  
2 armchairs, 1 sofa and 1 table.  
The separate sale of the individual elements is not allowed.

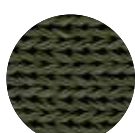
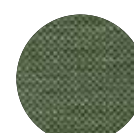
frame	rope	fabric
 antracite	 taupe	 T 11140
 antracite	 black brown	 T 11140
 white	 beige	 DT 044
 white	 dirty white	 venao
 black	 black green	 403.804



hydro draining technology

### finiture personalizzate custom finishes

combinazioni di materiali e finiture su richiesta.  
contattare l'ufficio commerciale per informazioni.

combinations of materials and finishes on request.  
contact the sales office for information.



sgabello  
stool

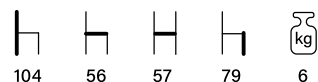

packaging 10 pz - 113x58x235 cm - 1,80 mc

430



### set

poltrona  
armchair

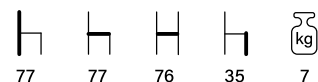

packaging 2 pz - 89x78x95 cm - 066 mc



divano 2 posti  
sofa 2 seat

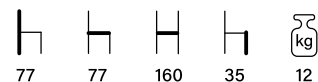

packaging 1 pz - 162x79x80 cm - 1,02 mc

3.740



tavolo/table  
mars medium

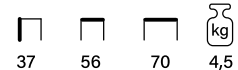

packaging 1 pz - 74x60x7 cm - 0,03 mc



divano  
sofa



packaging 2 pz - 190x95x80 cm - 1,40 mc

5.250

- struttura in alluminio verniciato a polveri
- resistente alle intemperie e alla luce solare (UV)
- corda in gomma con rivestimento in textilene-olefin
- 4 cuscini inclusi nel set
- gomma quick dry foam densità 30
- divano composto da 2 elementi

- aluminium frame powder coating
- weatherproof and sunlight resistant (UV) structure
- rope with rubber inside textilene-olefin outside
- 4 pillows included in the set
- quick dry foam 30 density
- sofa composed of 2 elements

frame

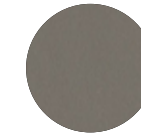

taupe

fabric

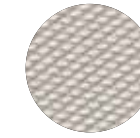

601.804z



hydro draining technology

finiture personalizzate  
custom finishes

combinazioni di materiali e finiture su richiesta.  
contattare l'ufficio commerciale per informazioni.

combinations of materials and finishes on request.  
contact the sales office for information.



sedia  
chair

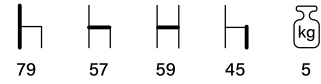

packaging 4 pz - 76x61x96 cm - 0,45 mc

307

- struttura in alluminio verniciato a polveri
- resistente alle intemperie e alla luce solare (UV)
- corda in gomma con rivestimento in textilene-olefin
- impilabile

- aluminium frame powder coating
- weatherproof and sunlight resistant (UV) structure
- rope with rubber inside
- stackable



hydro draining technology

finiture personalizzate  
custom finishes

combinazioni di materiali e finiture su richiesta.  
contattare l'ufficio commerciale per informazioni.

combinations of materials and finishes on request.  
contact the sales office for information.

frame

rope



antracite

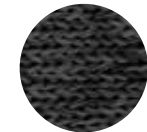

black grey



antracite



dark brown



taupe

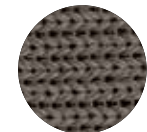

taupe



white

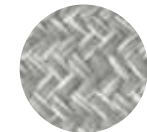

silver white



white

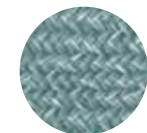

azure white



white

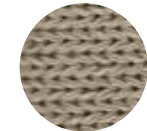

beige



pink



pink

sgabello  
stool

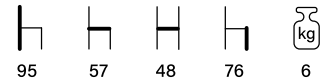

packaging 2 pz - 54x61x105 cm - 0,35 mc

337







poltroncina  
armchair

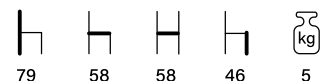

packaging 10 pz - 97x52x235 cm - 1,35 mc

337



sgabello  
stool

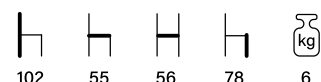

packaging 13 pz - 112x57x235cm - 1,70 mc

387



set

poltrona  
armchair

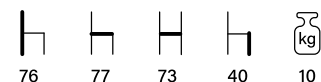

packaging \*



divano 2 posti  
sofa 2 seat

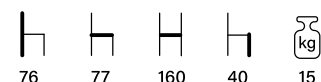

packaging \*

3.738



tavolo/table  
mars medium



\* packaging box include/including:  
2 poltrone/armchairs + 1 divano/sofa  
165x87x92 cm - 1,35 mc



lettino  
sunbed

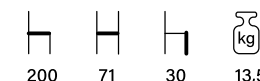

packaging 1 pz - 202x41x74 cm - 0,60 mc

1.188

descrizione /description

- struttura in alluminio verniciato a polveri
- resistente alle intemperie e alla luce solare (UV)
- corda in gomma con rivestimento in textilene-olefin
- cuscino poltrona/sgabello 5 cm con rivestimento textilene gomma quick dry foam densità 30
- cuscino set 10 cm con rivestimento textilene gomma quick dry foam densità 30
- cuscino lettino 8 cm con rivestimento textilene gomma quick dry foam densità 30
- impilabile

- aluminium frame powder coating
- weatherproof and sunlight resistant (UV) structure
- rope with rubber inside textilene-olefin outside
- armchair/stool cushion 5 cm textilene cover quick dry foam 30 density
- set cushion 10 cm textilene cover quick dry foam 30 density
- sunbed cushion 8 cm textilene cover quick dry foam 30 density
- stackable



love set è composto da:  
2 poltrone, 1 divano e 1 tavolino.  
la vendita separata dei singoli elementi  
non è consentita.

love set is composed by:  
2 armchairs, 1 sofa and 1 table.  
the separate sale of the individual elements  
is not allowed.

finiture standard/standard finishes

frame	rope	fabric
 antracite	 dark brown	 T 11826
 antracite	 dirty white	 carbon 3906
 antracite	 dark grey	 DT 052
 white	 beige	 DT 044



hydro draining technology

finiture personalizzate  
custom finishes

combinazioni di materiali e finiture su richiesta.  
contattare l'ufficio commerciale per informazioni.

combinations of materials and finishes on request.  
contact the sales office for information.



set

poltrona  
armchair

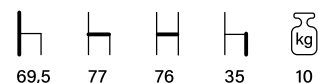

packaging 2 pz - 160x80x75 cm - 1,20 mc



divano 2 posti  
sofa 2 seat

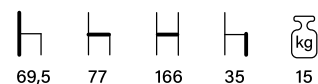

packaging \*



tavolo/table  
medium



\* packaging box include/including:  
1 divano/sofa + 1 tavolo/table  
170x80x75 cm - 1,20 mc

4.460

descrizione /description

- struttura in alluminio verniciato a polveri
- resistente alle intemperie e alla luce solare (UV)
- corda in gomma con rivestimento in textilene
- cuscino 10 cm con rivestimento textilene gomma quick dry foam densità 30
- piano tavolo in alluminio
- aluminium frame powder coating
- weatherproof and sunlight resistant (UV) structure
- rope with rubber inside textilene outside
- cushion 10 cm textilene cover quick dry foam 30 density
- table top in aluminium



cappuccio set è composto da:  
2 poltrone, 1 divano e 1 tavolino.  
la vendita separata dei singoli elementi  
non è consentita.

cappuccio set is composed by:  
2 armchairs, 1 sofa and 1 table.  
the separate sale of the individual elements  
is not allowed.

finiture standard/standard finishes

frame	rope	fabric
 antracite	 dark brown	 T 11826
 antracite	 dirty white	 carbon 3906



hydro draining technology

finiture personalizzate  
custom finishes

combinazioni di materiali e finiture su richiesta.  
contattare l'ufficio commerciale per informazioni.

combinations of materials and finishes on request.  
contact the sales office for information.



poltroncina  
armchair

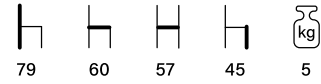

packaging 10 pz - 90x54x235 cm - 1,30 mc

320

- struttura in alluminio verniciato a polveri
- resistente alle intemperie e alla luce solare (UV)
- corda in gomma con rivestimento in textilene-olefin
- cuscino poltrona/sgabello 5 cm con rivestimento textilene gomma quick dry foam densità 30
- cuscino set 10 cm con rivestimento textilene gomma quick dry foam densità 30
- impilabile

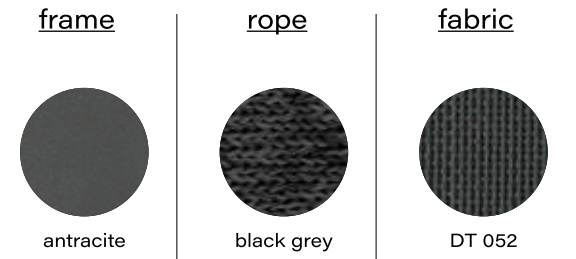

sgabello  
stool

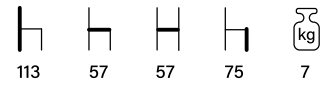

packaging 3 pz - 57x61x235 cm - 1,00 mc

406

- aluminium frame powder coating
- weatherproof and sunlight resistant (UV) structure
- rope with rubber inside textilene-olefin outside
- armchair/stool cushion 5 cm textilene cover quick dry foam 30 density
- set cushion 10 cm textilene cover quick dry foam 30 density
- stackable

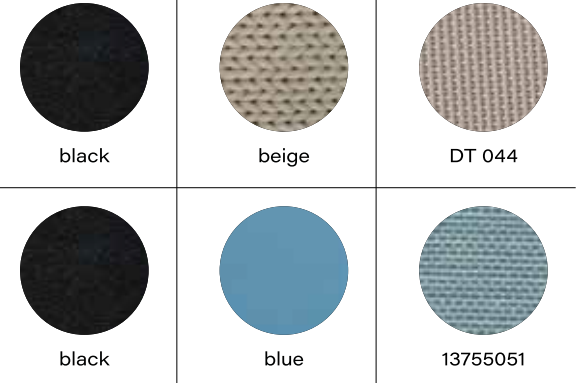

**belize set** è composto da:  
2 poltrone, 1 divano e 1 tavolino.  
La vendita separata dei singoli elementi non è consentita.

**belize set** is composed by:  
2 armchairs, 1 sofa and 1 table.  
The separate sale of the individual elements is not allowed.



set

poltrona  
armchair



packaging\*



divano 2 posti  
sofa 2 seat

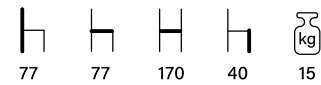

packaging\*

3.750



hydro draining technology

### finiture personalizzate custom finishes

combinazioni di materiali e finiture su richiesta.  
contattare l'ufficio commerciale per informazioni.

combinations of materials and finishes on request.  
contact the sales office for information.



tavolo/table

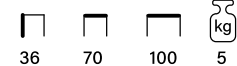

\* packaging box: 190x100x90 cm - 1,90 mc



sedia  
chair

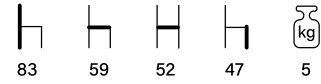

packaging 2 pz - 70x62x66 cm - 0,30 mc

460

- struttura in alluminio verniciato a polveri
- resistente alle intemperie e alla luce solare (UV)
- corda in gomma con rivestimento in textilene-olefin
- cuscino 5 cm con rivestimento textilene gomma quick dry foam densità 30
- aluminium frame powder coating
- weatherproof and sunlight resistant (UV) structure
- rope with rubber inside textilene-olefin outside
- cushion 5 cm textilene cover quick dry foam 30 density

frame	rope	fabric
 antracite	 black grey	 DT 052
 antracite	 beige	 DT 044



sgabello  
stool

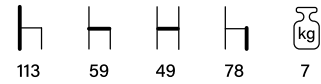

packaging 4 pz - 60x50x235 cm - 1,00 mc

485



hydro draining technology

### finiture personalizzate custom finishes

combinazioni di materiali e finiture su richiesta.  
contattare l'ufficio commerciale per informazioni.

combinations of materials and finishes on request.  
contact the sales office for information.





poltroncina  
armchair

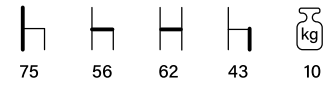

packaging 1 pz - 60x70x80 cm - 0,35 mc

643

- struttura in alluminio verniciato a polveri
- resistente alle intemperie e alla luce solare (UV)
- corda in gomma con rivestimento in textilene
- cuscino 5 cm con rivestimento textilene gomma quick dry foam densità 30

- aluminium frame powder coating
- weatherproof and sunlight resistant (UV) structure
- rope with rubber inside textilene outside
- cushion 5 cm textilene cover quick dry foam 30 density

frame



olive green

rope

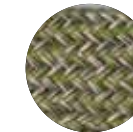

forest green

fabric

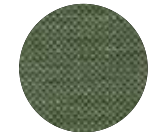

kitsilano 070



sgabello  
stool

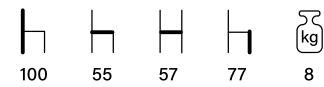

packaging 1 pz - 60x60x105 cm - 0,40 mc

525



**jungle set** è composto da:  
2 poltrone, 1 divano e 1 tavolino.  
La vendita separata dei singoli elementi non è consentita.

**jungle set** is composed by:  
2 armchairs, 1 sofa and 1 table.  
The separate sale of the individual elements is not allowed.

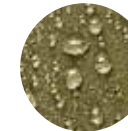

hydro draining technology

### finiture personalizzate custom finishes

combinazioni di materiali e finiture su richiesta.  
contattare l'ufficio commerciale per informazioni.

combinations of materials and finishes on request.  
contact the sales office for information.



set

poltrona  
armchair

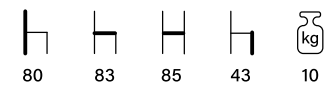

packaging 1 pz - 90x90x90 - 0,70 mc

divano 2 posti  
sofa 2 seat

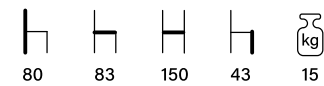

packaging 1 pz - 160x90x90 - 0,80 mc

7.150

tavolo/table



packaging 1 pz - 70x70x40 - 0,20 mc



set

poltrona  
armchair

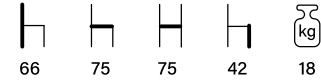

packaging 2 pz - 83x83x95 cm - 0,65 mc



divano 2 posti  
sofa 2 seat

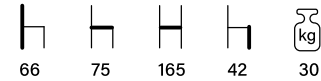

packaging \*

5.187



chaise longue

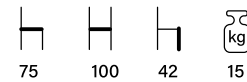

packaging \*



tavolo/table

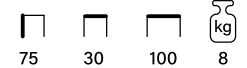

\* packaging box 3 pz - 167x77x68 cm - 0,90 mc

- struttura in alluminio verniciato a polveri
- resistente alle intemperie e alla luce solare (UV)
- corda in gomma con rivestimento in textilene-olefin
- cuscino 5 cm con rivestimento textilene gomma quick dry foam densità 30

- aluminium frame powder coating
- weatherproof and sunlight resistant (UV) structure
- rope with rubber inside textilene-olefin outside
- cushion 5 cm textilene cover quick dry foam 30 density



cortina set è composto da:  
2 poltrone, 1 divano, 1 chaise longue e 1 tavolino.  
La vendita separata dei singoli elementi non è consentita.

cortina set is composed by:  
2 armchairs, 1 sofa, 1 chaise longue and 1 table.  
The separate sale of the individual elements is not allowed.

frame



antracite

rope

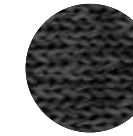

black grey

fabric

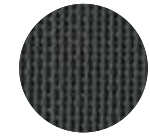

DT 052

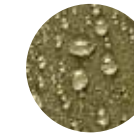

hydro draining technology

finiture personalizzate  
custom finishes

combinazioni di materiali e finiture su richiesta.  
contattare l'ufficio commerciale per informazioni.

combinations of materials and finishes on request.  
contact the sales office for information.



set

poltrona  
armchair

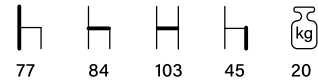

packaging 1 pz - 105x85xh80 - 0,70 mc



divano 2 posti  
sofa 2 seat

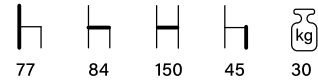

packaging\*



pouf



\* packaging box include/including:  
n° 1 divano/sofa + n°1 pouf  
160x105xh80 - 1,40 mc

5.575

- struttura in alluminio verniciato a polveri
- resistente alle intemperie e alla luce solare (UV)
- corda tonda olefin 6 mm
- rivestimento tessuto axroma idrorepellente
- cuscino schienale axroma idrorepellente

- aluminium frame powder coating
- weatherproof and sunlight resistant (UV) structure
- round rope olefin 6 mm
- seat cushion axroma waterproof fabric
- back cushion axroma waterproof fabric



cobbe set è composto da:  
2 poltrone, 1 divano e 1 pouf.  
la vendita separata dei singoli elementi  
non è consentita.

cobbe set is composed by:  
2 armchairs, 1 sofa and 1 pouf.  
the separate sale of the individual elements  
is not allowed.

frame	rope	fabric
 antracite	 black grey	 17737014
 white	 beige	 marble 3966



hydro draining technology

finiture personalizzate  
custom finishes

combinazioni di materiali e finiture su richiesta.  
contattare l'ufficio commerciale per informazioni.

combinations of materials and finishes on request.  
contact the sales office for information.





sedia  
chair

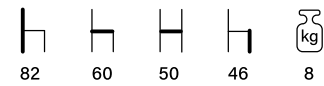

packaging 4 pz - 61x74x98 - 0,44 mc

275

- struttura in acciaio verniciato a polveri
- resistente alle intemperie e alla luce solare (UV)
- corda in gomma con rivestimento in textilene
- impilabile

- steel frame powder coating
- weatherproof and sunlight resistant (UV) structure
- rope with rubber inside
- stackable

frame



antracite

rope

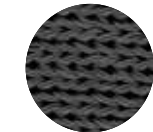

dark grey



silver

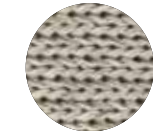

dirty white



antracite

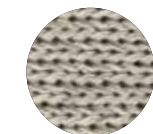

dirty white



black

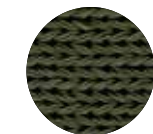

black green

finiture personalizzate  
custom finishes

combinazioni di materiali e finiture su richiesta.  
contattare l'ufficio commerciale per informazioni.

combinations of materials and finishes on request.  
contact the sales office for information.



poltroncina  
armchair

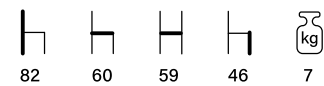

packaging 4 pz - 52x74x98 - 0,40 mc

287



sgabello  
stool

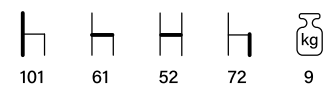

packaging 2 pz - 54x66x102 - 0,40 mc

362



sedia  
chair

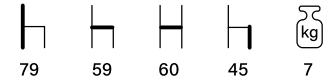

packaging 4 pz - 52x74x98 - 0,40 mc

232

- struttura in acciaio verniciato a polveri
- resistente alle intemperie e alla luce solare (UV)
- corda in gomma con rivestimento in textilene
- impilabile
- steel frame powder coating
- weatherproof and sunlight resistant (UV) structure
- rope with rubber inside
- stackable

frame



antracite

rope

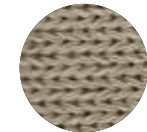

beige



antracite

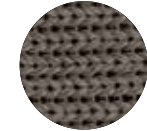

taupe



antracite



dark brown



black

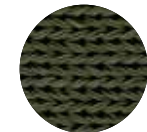

dark green

finiture personalizzate  
custom finishes

combinazioni di materiali e finiture su richiesta.  
contattare l'ufficio commerciale per informazioni.

combinations of materials and finishes on request.  
contact the sales office for information.



sgabello  
stool

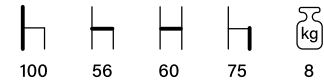

packaging 2 pz - 54x66x102 - 0,40 mc

250

# star set

€ prezzo/price



## set

### poltrona armchair

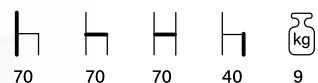

packaging 2 pz - 78x74x91 cm - 0,60 mc

### divano 2 posti sofa 2 seat

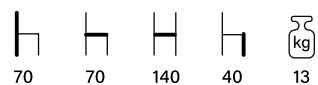

packaging\*

### tavolo/table medium

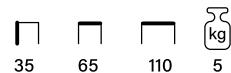

\* packaging box include/including:  
1 divano/sofa + 1 tavolo/table  
142x72x71 cm - 0,80 mc

2.625

## descrizione /description

- struttura in alluminio verniciato a polveri
- resistente alle intemperie e alla luce solare (UV)
- cuscino 10 cm con rivestimento sunproof  
gomma quick dry foam densità 30
- piano in vetro temperato grigio
- aluminium frame powder coating
- weatherproof and sunlight resistant (UV) structure
- cushion 10 cm sunproof cover  
quick dry foam 30 density
- grey tempered glass top

## finiture standard/standard finishes

### frame



antracite

### fabric

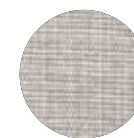

venao 165



white

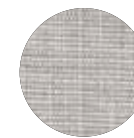

venao 165



taupe

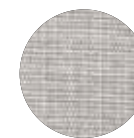

venao 165

colore RAL  
a richiesta  
RAL color  
on demand

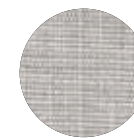

venao 165



hydro draining technology

## finiture personalizzate custom finishes

combinazioni di materiali e finiture su richiesta.  
contattare l'ufficio commerciale per informazioni.

combinations of materials and finishes on request.  
contact the sales office for information.

# santiago

€ prezzo/price



lettino sunbed

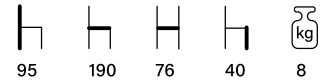

packaging 2 pz - 220x80x50 cm - 1 mc  
packaging 16 pz - 220x80x225 cm - 4 mc

481

## descrizione /description

- struttura in alluminio verniciato a polveri
- resistente alle intemperie e alla luce solare (UV)
- rivestimento in textilene
- ruote teflon trasparente
- schienale regolabile in 5 posizioni
- impilabile
- aluminium frame powder coating
- weatherproof and sunlight resistant (UV) structure
- textilene outside
- transparent teflon wheels
- backrest adjustable in 5 positions
- stackable

## finiture standard/standard finishes

### frame



antracite



taupe



white

### fabric

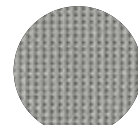

light grey

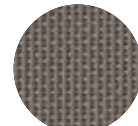

taupe



white



hydro draining technology

### finiture personalizzate custom finishes

combinazioni di materiali e finiture su richiesta. contattare l'ufficio commerciale per informazioni.

combinations of materials and finishes on request. contact the sales office for information.

# argentina

€ prezzo/price



lettino singolo single sunbed

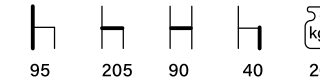

packaging 1 pz - 210x95x50 cm - 1 mc

2.000

lettino doppio double sunbed

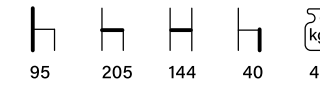

packaging 1 pz - 210x144x50 cm - 1,5 mc

2.500

## descrizione /description

- struttura in alluminio verniciato a polveri
- resistente alle intemperie e alla luce solare (UV)
- rivestimento sunbrella
- schienale regolabile in 5 posizioni
- spessore 18 cm
- aluminium frame powder coating
- weatherproof and sunlight resistant (UV) structure
- sunbrella outside
- backrest adjustable in 5 positions
- thickness 18 cm

## finiture standard/standard finishes

### frame



antracite



white

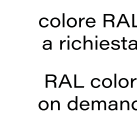

colore RAL a richiesta



RAL color on demand

### fabric



lead chine

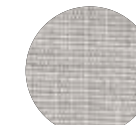

lead chine



lead chine



hydro draining technology

### finiture personalizzate custom finishes

combinazioni di materiali e finiture su richiesta. contattare l'ufficio commerciale per informazioni.

combinations of materials and finishes on request. contact the sales office for information.



## lettino daybed

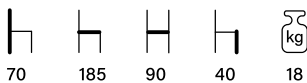

packaging 2 pz - 190x100x75 cm - 1,50 mc

3.687

### descrizione /description

- struttura in alluminio verniciato a polveri
- resistente alle intemperie e alla luce solare (UV)
- corda in gomma con rivestimento in textilene-olefin
- 6 cuscini inclusi nel set
- cuscino set 10 cm con rivestimento textilene gomma quick dry foam densità 30
- aluminium frame powder coating
- weatherproof and sunlight resistant (UV) structure
- rope with rubber inside textilene-olefin outside
- 6 pillows included in the set
- set cushion 10 cm textilene cover quick dry foam 30 density

### finiture standard/standard finishes

#### frame



antracite

#### fabric

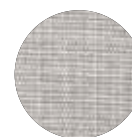

beige



white

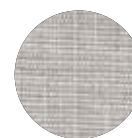

beige



hydro draining technology

### finiture personalizzate custom finishes

combinazioni di materiali e finiture su richiesta.  
contattare l'ufficio commerciale per informazioni.

combinations of materials and finishes on request.  
contact the sales office for information.



pouf

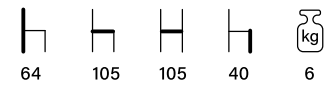

packaging 1 pz - 110x110x70 - mc 0,80

950

descrizione /description

- seduta imbottita
- microsfere di polipropilene contenute in una fodera in tessuto spaziato in poliestere rivestimento sunproof
- resistente alle intemperie e alla luce solare (UV)
- padded seat
- padding in polypropylene microspheres encased in a covering made of three-dimensional polyester fabric with sunproof cover
- weatherproof and sunlight resistant (UV) structure

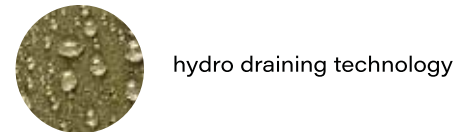

finiture personalizzate  
custom finishes

combinazioni di materiali e finiture su richiesta. contattare l'ufficio commerciale per informazioni.

combinations of materials and finishes on request. contact the sales office for information.

finiture standard/standard finishes

fabric

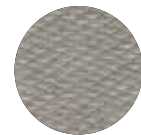

604.804z

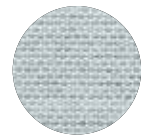

sunbrella curacao 3964

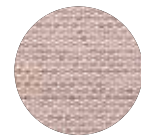

sunbrella blush 3965

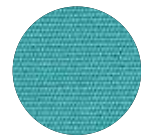

sunbrella aruba 5416

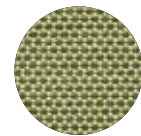

sunbrella lichen 3970

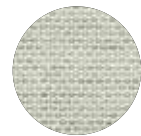

sunbrella mint 3967



chaise longue

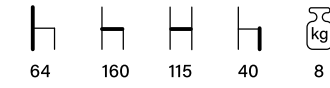

packaging 1 pz - 110x110x70 - mc 1,30

1.100

descrizione /description

- seduta imbottita
- microsfere di polipropilene contenute in una fodera in tessuto spaziato in poliestere rivestimento sunproof
- resistente alle intemperie e alla luce solare (UV)
- padded seat
- padding in polypropylene microspheres encased in a covering made of three-dimensional polyester fabric with sunproof cover
- weatherproof and sunlight resistant (UV) structure

finiture standard/standard finishes

fabric

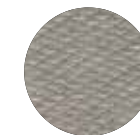

604.804z



finiture personalizzate  
custom finishes

combinazioni di materiali e finiture su richiesta. contattare l'ufficio commerciale per informazioni.

combinations of materials and finishes on request. contact the sales office for information.





poltrona  
armchair

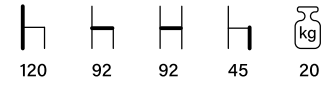

packaging 1 pz - 150x150x150 cm - 2,75 mc

2.615

descrizione /description

- struttura in alluminio verniciato a polveri
- resistente alle intemperie e alla luce solare (UV)
- corda in gomma con rivestimento olefin
- 1 cuscino poggiaschiena incluso
- gomma quick dry foam densità 30
- aluminium frame powder coating
- weatherproof and sunlight resistant (UV) structure
- rope with rubber olefin outside
- 1 backrest cushion included
- quick dry foam 30 density

finiture standard/standard finishes

frame	fabric	fabric
 black	 red	 sunbrella carbon 3906
 white	 azure white	 venao 165

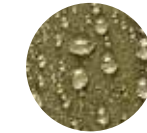

hydro draining technology

finiture personalizzate  
custom finishes

combinazioni di materiali e finiture su richiesta.  
contattare l'ufficio commerciale per informazioni.

combinations of materials and finishes on request.  
contact the sales office for information.





**elemento 115**  
**element 115**



packaging 1 pz - 115x90x90 cm - 0,90 mc

**elemento 74**  
**element 74**

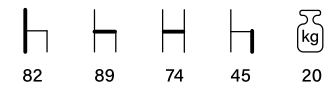

packaging 1 pz - 80x90x90 cm - 0,60 mc

**pouf**

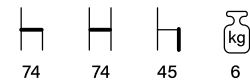

packaging 1 pz - 80x80x50 cm - 0,32 mc

**angolo 90**  
**corner 90**

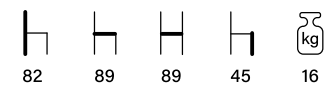

packaging 1 pz - 90x90x85 cm - 0,68 mc

5.160

- struttura in alluminio verniciato a polveri
- resistente alle intemperie e alla luce solare (UV)
- gomma quick dry foam densità 30
- rivestimento tessuto sunbrella

- aluminium frame powder coating
- weatherproof and sunlight resistant (UV) structure
- quick dry foam 30 density
- sunbrella fabric upholstery

fabric



sunbrella sooty 3758

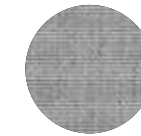

sunbrella lead chinè

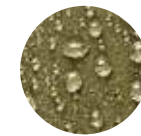

hydro draining technology

**finiture personalizzate**  
**custom finishes**

combinazioni di materiali e finiture su richiesta.  
contattare l'ufficio commerciale per informazioni.

combinations of materials and finishes on request.  
contact the sales office for information.



## elemento 50 element 50

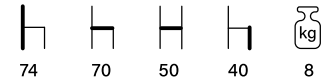

packaging 1 pz - 75x60x80 cm - 0,36 mc

## elemento 100 element 100

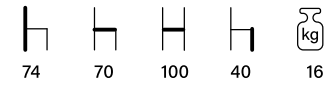

packaging 1 pz - 75x110x80 cm - 0,66 mc

## pouf

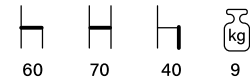

packaging 1 pz - 70x80x40 cm - 0,25 mc

## angolo 90 corner 90

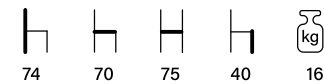

packaging 1 pz - 74x75x74 cm - 0,55 mc

su richiesta  
on request

### descrizione /description

- struttura in acciaio interamente stampata in poliuretano schiumato ignifugo
- rivestimento in tessuto sunbrella su richiesta
- pedini in plastica nero
- steel frame entirely molded in fireproof polyurethane foam
- upholstery in sunbrella fabric on request
- black plastic feets

### finiture standard/standard finishes



hydro draining technology

### finiture personalizzate custom finishes

combinazioni di materiali e finiture su richiesta. contattare l'ufficio commerciale per informazioni.

combinations of materials and finishes on request. contact the sales office for information.



## lettino sunbed

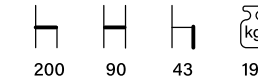

packaging 1 pz - 210x105x50 cm - 1,10 mc

4.490

### descrizione /description

- struttura in alluminio verniciato a polveri
- resistente alle intemperie e alla luce solare (UV)
- corda in gomma con rivestimento in textilene-olefin
- cuscino lettino 38 cm con rivestimento
- rivestimento in tessuto sunbrella
- aluminium frame powder coating
- weatherproof and sunlight resistant (UV) structure
- rope with rubber inside textilene-olefin outside
- sunbed cushion 38 cm textilene cover
- quick dry foam 30 density
- upholstery in sunbrella fabric

### finiture standard/standard finishes

#### frame



white

#### rope

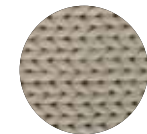

beige

#### fabric



marble 3966



hydro draining technology

### finiture personalizzate custom finishes

combinazioni di materiali e finiture su richiesta. contattare l'ufficio commerciale per informazioni.

combinations of materials and finishes on request. contact the sales office for information.



poltrona dondolo  
hanging chair

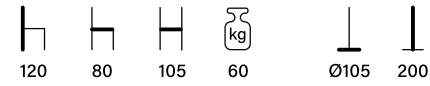

packaging 1 pz - 2 mc

1.100

## descrizione /description

- struttura in acciaio verniciato a polveri
- resistente alle intemperie e alla luce solare (UV)
- corda in gomma con rivestimento in wicker
- cuscino 15 cm con rivestimento in tessuto
- capacità di carico 120 kg
- steel frame powder coating
- weatherproof and sunlight resistant (UV) structure
- rope wicker with rubber inside
- cushion 15 cm fabric cover
- load capacity 120 kg

## finiture standard/standard finishes

### frame



brown

### rope



dark brown

### fabric

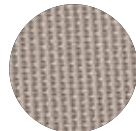

beige



hydro draining technology

### finiture personalizzate custom finishes

combinazioni di materiali e finiture su richiesta.  
contattare l'ufficio commerciale per informazioni.

combinations of materials and finishes on request.  
contact the sales office for information.



lampada  
lamp



packaging 1 pz 370x370x260 - mc 0,040

270

## descrizione /description

- struttura in alluminio verniciato a polveri
- resistente alle intemperie e alla luce (uv)
- corda in gomma con rivestimento in textilene 6 mm
- led luci a batteria compreso
- aluminium frame powder coating
- weatherproof and sunlight resistant (uv) structure
- rope with rubber inside textilene 6mm
- kit led including

## finiture standard/standard finishes

### frame



antracite

### rope

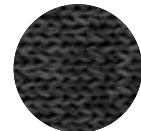

black grey



white

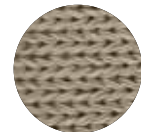

beige

### finiture personalizzate custom finishes

combinazioni di materiali e finiture su richiesta.  
contattare l'ufficio commerciale per informazioni.

combinations of materials and finishes on request.  
contact the sales office for information.

# outdoor carpets

€ prezzo/price



tappeto 1  
carpet 1

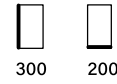

2.000

tappeto 2  
carpet 2

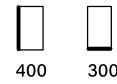

3.660

tappeto 3  
carpet 3

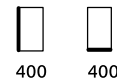

4.740

tappeto 4  
carpet 4



3.660

tappeto 5  
carpet 5



4.740

## descrizione /description

- tappeto sintetico 100% polipropilene
- bordo cotone-pvc-textilene
- synthetic carpet 100% polypropylene
- cotton-pvc-textilene border

# flower box

€ prezzo/price



fioriera  
flower box

su richiesta  
on request

## descrizione /description

- lamiera zincata a caldo e verniciato a polveri per uso esterno
- disponibile con ruote
- dimensioni su richiesta
- planter in hot galvanized e powder coated sheet metal for outdoor use
- available with wheels
- dimensions on request

## finiture standard/standard finishes

### finiture personalizzate custom finishes

combinazioni di materiali e finiture su richiesta. contattare l'ufficio commerciale per informazioni.  
combinations of materials and finishes on request. contact the sales office for information.

## finiture standard/standard finishes

### fabric



melange 5301

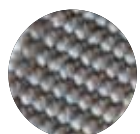

bianco 5701

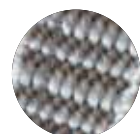

lino 5601

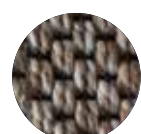

sabbia 12



nocciola 16



taupè 31



grigio 72



perla 22



antracite 40

basi tavolini / table bases

base tavolo in lamiera verniciato a polveri, colonna quadrata o tonda, piastra per fissaggio piano, con piedini regolabili.  
flat steel base powder coating, square or round column, plat support for table top, with adjustable feet

100% produzione italiana / 100% made in italy

su richiesta i basamenti sono disponibili in qualsiasi misura / on request, the bases are available in any size

disponibili su richiesta altre finiture ral / other ral finishes on request

disponibili su richiesta trattamenti di cataforesi e zincatura per zone marine  
cataphoresis and galvanizing treatments for marine areas are available on request

prodotto product	codice code	misura basamento base size	misura colonna column size	finitura finishing	altezza height	peso weight	prezzo price
alaska	ft 050	mm	mm	ral	mm	kg	€
	ft 050	400x400x10	Ø 60 Ø 80 60x60 80x80	black 9017 white 9016 antracite 7021 aluminium 9006 grey beige 7032	450 - 650	15	210
	ft 050	400x400x10	Ø 60 Ø 80 60x60 80x80	black 9017 white 9016 antracite 7021 aluminium 9006 grey beige 7032	720	16	210
	ft 050	400x400x10	Ø 60 Ø 80 60x60 80x80	black 9017 white 9016 antracite 7021 aluminium 9006 grey beige 7032	1100	17	226

prodotto product	codice code	misura basamento base size	misura colonna column size	finitura finishing	altezza height	peso weight	prezzo price
alaska	ft 050	mm	mm	ral	mm	kg	€
	ft 050	450x450x10	Ø 60 Ø 80 60x60 80x80	black 9017 white 9016 antracite 7021 aluminium 9006 grey beige 7032	450 - 650	16	233
	ft 050	450x450x10	Ø 60 Ø 80 60x60 80x80	black 9017 white 9016 antracite 7021 aluminium 9006 grey beige 7032	720	17	233
	ft 050	450x450x10	Ø 60 Ø 80 60x60 80x80	black 9017 white 9016 antracite 7021 aluminium 9006 grey beige 7032	1100	18	249

prodotto product	codice code	misura basamento base size	misura colonna column size	finitura finishing	altezza height	peso weight	prezzo price
alaska	ft 050	mm	mm	ral	mm	kg	€
	ft 050	500x500x10	Ø 60 Ø 80 60x60 80x80	black 9017 white 9016 antracite 7021 aluminium 9006 grey beige 7032	450 - 650	17	253
	ft 050	500x500x10	Ø 60 Ø 80 60x60 80x80	black 9017 white 9016 antracite 7021 aluminium 9006 grey beige 7032	720	18	253
	ft 050	500x500x10	Ø 60 Ø 80 60x60 80x80	black 9017 white 9016 antracite 7021 aluminium 9006 grey beige 7032	1100	19	269

prodotto product	codice code	misura basamento base size	misura colonna column size	finitura finishing	altezza height	peso weight	prezzo price
alaska	ft 050	mm	mm	ral	mm	kg	€
	ft 050	600x600x10	Ø 60 Ø 80 60x60 80x80	black 9017 white 9016 antracite 7021 aluminium 9006 grey beige 7032	450 - 650	24	326
	ft 050	600x600x10	Ø 60 Ø 80 60x60 80x80	black 9017 white 9016 antracite 7021 aluminium 9006 grey beige 7032	720	25	326
	ft 050	600x600x10	Ø 60 Ø 80 60x60 80x80	black 9017 white 9016 antracite 7021 aluminium 9006 grey beige 7032	1100	26	342

prodotto product	codice code	misura basamento base size	misura colonna column size	finitura finishing	altezza height	peso weight	prezzo price
alaska	ft 050 - 2 col	mm	mm	ral	mm	kg	€
	ft 050 - 2 col	600x450x10	Ø 60 Ø 80 60x60 80x80	black 9017 white 9016 antracite 7021 aluminium 9006 grey beige 7032	450 - 650	25	370
	ft 050 - 2 col	600x450x10	Ø 60 Ø 80 60x60 80x80	black 9017 white 9016 antracite 7021 aluminium 9006 grey beige 7032	720	27	370
	ft 050 - 2 col	600x450x10	Ø 60 Ø 80 60x60 80x80	black 9017 white 9016 antracite 7021 aluminium 9006 grey beige 7032	1100	29	402



basi tavolini / table bases

base tavolo in acciaio inox satinato 304 colonna quadrata o tonda acciaio inox satinato, piastra per fissaggio piano, con piedini regolabili  
table base in satin stainless steel 304 square or round column in satin stainless steel, plate support for table top, with adjustable feet

100% produzione italiana / 100% made in italy

su richiesta i basamenti sono disponibili in qualsiasi misura / on request, the bases are available in any size

disponibili su richiesta trattamenti di cataforesi e zincatura per zone marine  
cataphoresis and galvanizing treatments for marine areas are available on request

prodotto product	codice code	misura basamento base size	misura colonna column size	finitura finishing	altezza height	peso weight	prezzo price
alaska	ft 060	mm	mm	inox	mm	kg	€
	ft 060	400x400x10	60x60 - 80x80	304	450 - 650	15	260
	ft 060	400x400x10	60x60 - 80x80	304	720	16	260
	ft 060	400x400x10	60x60 - 80x80	304	1100	17	293

prodotto product	codice code	misura basamento base size	misura colonna column size	finitura finishing	altezza height	peso weight	prezzo price
alaska	ft 060	mm	mm	inox	mm	kg	€
	ft 060	450x450x10	60x60 - 80x80	304	450 - 650	16	286
	ft 060	450x450x10	60x60 - 80x80	304	720	17	286
	ft 060	450x450x10	60x60 - 80x80	304	1100	18	313

prodotto product	codice code	misura basamento base size	misura colonna column size	finitura finishing	altezza height	peso weight	prezzo price
alaska	ft 060	mm	mm	inox	mm	kg	€
	ft 060	500x500x10	60x60 - 80x80	304	450 - 650	17	326
	ft 060	500x500x10	60x60 - 80x80	304	720	18	326
	ft 060	500x500x10	60x60 - 80x80	304	1100	19	346

prodotto product	codice code	misura basamento base size	misura colonna column size	finitura finishing	altezza height	peso weight	prezzo price
alaska	ft 060 - 2 col	mm	mm	inox	mm	kg	€
	ft 060 - 2 col	600x450x10	60x60 - 80x80	304	450 - 650	25	420
	ft 060 - 2 col	600x450x10	60x60 - 80x80	304	720	27	420
	ft 060 - 2 col	600x450x10	60x60 - 80x80	304	1100	29	486

prodotto product	codice code	misura basamento base size	misura colonna column size	finitura finishing	altezza height	peso weight	prezzo price
alaska	ft 070	mm	mm	inox	mm	kg	€
	ft 070	400x400x10	Ø 80	304	450 - 650	15	226
	ft 070	400x400x10	Ø 80	304	720	16	226
	ft 070	400x400x10	Ø 80	304	1100	17	260

prodotto product	codice code	misura basamento base size	misura colonna column size	finitura finishing	altezza height	peso weight	prezzo price
alaska	ft 070	mm	mm	inox	mm	kg	€
	ft 070	450x450x10	Ø 80	304	450 - 650	16	246
	ft 070	450x450x10	Ø 80	304	720	17	246
	ft 070	450x450x10	Ø 80	304	1100	18	280

prodotto product	codice code	misura basamento base size	misura colonna column size	finitura finishing	altezza height	peso weight	prezzo price
alaska	ft 070	mm	mm	inox	mm	kg	€
	ft 070	500x500x10	Ø 80	304	450 - 650	17	286
	ft 070	500x500x10	Ø 80	304	720	18	286
	ft 070	500x500x10	Ø 80	304	1100	19	320

prodotto product	codice code	misura basamento base size	misura colonna column size	finitura finishing	altezza height	peso weight	prezzo price
alaska	ft 070 - 2 col	mm	mm	inox	mm	kg	€
	ft 070 - 2 col	600x450x10	Ø 80	304	450 - 650	25	386
	ft 070 - 2 col	600x450x10	Ø 80	304	720	27	386
	ft 070 - 2 col	600x450x10	Ø 80	304	1100	29	453

prodotto product	codice code	misura basamento base size	misura colonna column size	finitura finishing	altezza height	peso weight	prezzo price
alaska	ft 060	mm	mm	inox	mm	kg	€
	ft 060	400x400x10	60x60 - 80x80	S - C *	450 - 650	15	273
	ft 060	400x400x10	60x60 - 80x80	S - C *	720	16	273
	ft 060	400x400x10	60x60 - 80x80	S - C *	1100	17	306

prodotto product	codice code	misura basamento base size	misura colonna column size	finitura finishing	altezza height	peso weight	prezzo price
alaska	ft 060	mm	mm	inox	mm	kg	€
	ft 060	450x450x10	60x60 - 80x80	S - C *	450 - 650	16	293
	ft 060	450x450x10	60x60 - 80x80	S - C *	720	17	293
	ft 060	450x450x10	60x60 - 80x80	S - C *	1100	18	326

prodotto product	codice code	misura basamento base size	misura colonna column size	finitura finishing	altezza height	peso weight	prezzo price
alaska	ft 060	mm	mm	inox	mm	kg	€
	ft 060	500x500x10	60x60 - 80x80	S - C *	450 - 650	17	333
	ft 060	500x500x10	60x60 - 80x80	S - C *	720	18	333
	ft 060	500x500x10	60x60 - 80x80	S - C *	1100	19	366

prodotto product	codice code	misura basamento base size	misura colonna column size	finitura finishing	altezza height	peso weight	prezzo price
alaska	ft 060 - 2 col	mm	mm	inox	mm	kg	€
	ft 060 - 2 col	600x450x10	60x60 - 80x80	S - C *	450 - 650	25	480
	ft 060 - 2 col	600x450x10	60x60 - 80x80	S - C *	720	27	480
	ft 060 - 2 col	600x450x10	60x60 - 80x80	S - C *	1100	29	546

basi tavolini / table bases

base tavolo in lamiera verniciato a polveri, colonna quadrata o tonda, piastra per fissaggio piano, con piedini regolabili.  
flat steel base powder coating, square or round column, plat support for table top, with adjustable feet

100% produzione italiana / 100% made in italy

su richiesta i basamenti sono disponibili in qualsiasi misura / on request, the bases are available in any size

disponibili su richiesta altre finiture ral / other ral finishes on request

disponibili su richiesta trattamenti di cataforesi e zincatura per zone marine  
cataphoresis and galvanizing treatments for marine areas are available on request

prodotto product	codice code	misura basamento base size	misura colonna column size	finitura finishing	altezza height	peso weight	prezzo price
metropolitan	ft 055	mm	mm	ral	mm	kg	€
	ft 055	Ø400x10	Ø 60 Ø 80	black 9017 white 9016 antracite 7021 aluminium 9006 grey beige 7032	450 - 650	14	204
	ft 055	Ø400x10	Ø 60 Ø 80	black 9017 white 9016 antracite 7021 aluminium 9006 grey beige 7032	720	15	204
	ft 055	Ø400x10	Ø 60 Ø 80	black 9017 white 9016 antracite 7021 aluminium 9006 grey beige 7032	1100	16	217

prodotto product	codice code	misura basamento base size	misura colonna column size	finitura finishing	altezza height	peso weight	prezzo price
metropolitan	ft 055	mm	mm	ral	mm	kg	€
	ft 055	Ø450x10	Ø 60 Ø 80	black 9017 white 9016 antracite 7021 aluminium 9006 grey beige 7032	450 - 650	15	228
	ft 055	Ø450x10	Ø 60 Ø 80	black 9017 white 9016 antracite 7021 aluminium 9006 grey beige 7032	720	16	228
	ft 055	Ø450x10	Ø 60 Ø 80	black 9017 white 9016 antracite 7021 aluminium 9006 grey beige 7032	1100	17	241



prodotto product	codice code	misura basamento base size	misura colonna column size	finitura finishing	altezza height	peso weight	prezzo price
metropolitan	ft 055	mm	mm	ral	mm	kg	€
	ft 055	Ø500x10	Ø 60 Ø 80	black 9017 white 9016 antracite 7021 aluminium 9006 grey beige 7032	450 - 650	16	252
	ft 055	Ø500x10	Ø 60 Ø 80	black 9017 white 9016 antracite 7021 aluminium 9006 grey beige 7032	720	17	252
	ft 055	Ø500x10	Ø 60 Ø 80	black 9017 white 9016 antracite 7021 aluminium 9006 grey beige 7032	1100	18	265

prodotto product	codice code	misura basamento base size	misura colonna column size	finitura finishing	altezza height	peso weight	prezzo price
metropolitan	ft 055	mm	mm	ral	mm	kg	€
	ft 055	Ø600x10	Ø 60 Ø 80 Ø 100	black 9017 white 9016 antracite 7021 aluminium 9006 grey beige 7032	450 - 650	17	313
	ft 055	Ø600x10	Ø 60 Ø 80 Ø 100	black 9017 white 9016 antracite 7021 aluminium 9006 grey beige 7032	720	18	313
	ft 055	Ø600x10	Ø 60 Ø 80 Ø 100	black 9017 white 9016 antracite 7021 aluminium 9006 grey beige 7032	1100	19	326

basi tavolini / table bases

base tavolo in acciaio inox satinato 304 colonna quadrata o tonda acciaio inox satinato, piastra per fissaggio piano, con piedini regolabili  
table base in satin stainless steel 304 square or round column in satin stainless steel, plate support for table top, with adjustable feet

100% produzione italiana / 100% made in italy

su richiesta i basamenti sono disponibili in qualsiasi misura / on request, the bases are available in any size

disponibili su richiesta trattamenti di cataforesi e zincatura per zone marine  
cathaphoresis and galvanizing treatments for marine areas are available on request

prodotto product	codice code	misura basamento base size	misura colonna column size	finitura finishing	altezza height	peso weight	prezzo price
metropolitan	ft 065	mm	mm	inox	mm	kg	€
	ft 065	Ø400x10	Ø 80	304	450 - 650	16	226
	ft 065	Ø400x10	Ø 80	304	720	17	226
	ft 065	Ø400x10	Ø 80	304	1100	18	253

prodotto product	codice code	misura basamento base size	misura colonna column size	finitura finishing	altezza height	peso weight	prezzo price
metropolitan	ft 065	mm	mm	inox	mm	kg	€
	ft 065	Ø470x10	Ø 80	304	450 - 650	18	253
	ft 065	Ø470x10	Ø 80	304	720	19	253
	ft 065	Ø470x10	Ø 80	304	1100	20	286

prodotto product	codice code	misura basamento base size	misura colonna column size	finitura finishing	altezza height	peso weight	prezzo price
metropolitan	ft 065	mm	mm	inox	mm	kg	€
	ft 065	Ø580x10	Ø 80	304	450 - 650	22	320
	ft 065	Ø580x10	Ø 80	304	720	23	320
	ft 065	Ø580x10	Ø 80	304	1100	24	353

prodotto product	codice code	misura basamento base size	misura colonna column size	finitura finishing	altezza height	peso weight	prezzo price
metropolitan	ft 065	mm	mm	inox	mm	kg	€
	ft 065	Ø700x10	Ø 80	304	450 - 650	23	413
	ft 065	Ø700x10	Ø 80	304	720	24	413
	ft 065	Ø700x10	Ø 80	304	1100	25	440

prodotto product	codice code	misura basamento base size	misura colonna column size	finitura finishing	altezza height	peso weight	prezzo price
metropolitan	ft 065	mm	mm	inox	mm	kg	€
	ft 065	Ø400x10	Ø 80	S - C *	450 - 650	16	233
	ft 065	Ø400x10	Ø 80	S - C *	720	17	233
	ft 065	Ø400x10	Ø 80	S - C *	1100	18	266

prodotto product	codice code	misura basamento base size	misura colonna column size	finitura finishing	altezza height	peso weight	prezzo price
metropolitan	ft 065	mm	mm	inox	mm	kg	€
	ft 065	Ø470x10	Ø 80	S - C *	450 - 650	18	260
	ft 065	Ø470x10	Ø 80	S - C *	720	19	260
	ft 065	Ø470x10	Ø 80	S - C *	1100	20	293

prodotto product	codice code	misura basamento base size	misura colonna column size	finitura finishing	altezza height	peso weight	prezzo price
metropolitan	ft 065	mm	mm	inox	mm	kg	€
	ft 065	Ø580x10	Ø 80	S - C *	450 - 650	22	326
	ft 065	Ø580x10	Ø 80	S - C *	720	23	326
	ft 065	Ø580x10	Ø 80	S - C *	1100	24	333

prodotto product	codice code	misura basamento base size	misura colonna column size	finitura finishing	altezza height	peso weight	prezzo price
metropolitan	ft 065	mm	mm	inox	mm	kg	€
	ft 065	Ø700x10	Ø 80	S - C *	450 - 650	23	400
	ft 065	Ø700x10	Ø 80	S - C *	720	24	400
	ft 065	Ø700x10	Ø 80	S - C *	1100	25	433

basi tavolini / table bases

base tavolo in lamiera verniciato a polveri, colonna quadrata o tonda, piastra per fissaggio piano, con piedini regolabili.  
flat steel base powder coating, square or round column, plat support for table top, with adjustable feet

100% produzione italiana / 100% made in italy

su richiesta i basamenti sono disponibili in qualsiasi misura / on request, the bases are available in any size

disponibili su richiesta altre finiture ral / other ral finishes on request

disponibili su richiesta trattamenti di cataforesi e zincatura per zone marine  
cataphoresis and galvanizing treatments for marine areas are available on request

prodotto product	codice code	misura basamento base size	misura colonna column size	finitura finishing	altezza height	peso weight	prezzo price
mojito	ft 016	mm	mm	ral	mm	kg	€
	ft 016	400x400x10	25X25	black 9017 white 9016 antracite 7021 aluminium 9006 grey beige 7032	450 - 650	16	240
	ft 016	400x400x10	25X25	black 9017 white 9016 antracite 7021 aluminium 9006 grey beige 7032	720	17	240
	ft 016	400x400x10	25X25	black 9017 white 9016 antracite 7021 aluminium 9006 grey beige 7032	1100	18	266

prodotto product	codice code	misura basamento base size	misura colonna column size	finitura finishing	altezza height	peso weight	prezzo price
mojito	ft 016	mm	mm	ral	mm	kg	€
	ft 016	450x450x10	25X25	black 9017 white 9016 antracite 7021 aluminium 9006 grey beige 7032	450 - 650	17	260
	ft 016	450x450x10	25X25	black 9017 white 9016 antracite 7021 aluminium 9006 grey beige 7032	720	18	260
	ft 016	450x450x10	25X25	black 9017 white 9016 antracite 7021 aluminium 9006 grey beige 7032	1100	19	286

prodotto product	codice code	misura basamento base size	misura colonna column size	finitura finishing	altezza height	peso weight	prezzo price
mojito	ft 016	mm	mm	ral	mm	kg	€
	ft 016	500x500x10	25X25	black 9017 white 9016 antracite 7021 aluminium 9006 grey beige 7032	450 - 650	18	286
	ft 016	500x500x10	25X25	black 9017 white 9016 antracite 7021 aluminium 9006 grey beige 7032	720	19	286
	ft 016	500x500x10	25X25	black 9017 white 9016 antracite 7021 aluminium 9006 grey beige 7032	1100	20	313

prodotto product	codice code	misura basamento base size	misura colonna column size	finitura finishing	altezza height	peso weight	prezzo price
mojito	ft 016	mm	mm	ral	mm	kg	€
	ft 016	600x600x10	25X25	black 9017 white 9016 antracite 7021 aluminium 9006 grey beige 7032	450 - 650	19	400
	ft 016	600x600x10	25X25	black 9017 white 9016 antracite 7021 aluminium 9006 grey beige 7032	720	20	400
	ft 016	600x600x10	25X25	black 9017 white 9016 antracite 7021 aluminium 9006 grey beige 7032	1100	21	440

basi tavolini / table bases

base tavolo in lamiera verniciato a polveri, colonne tonde, piastra per fissaggio piano, con piedini regolabili  
table base in powder-coated sheet metal, round columns, plat support for table top. with adjustable feet

100% produzione italiana / 100% made in italy

su richiesta i basamenti sono disponibili in qualsiasi misura / on request, the bases are available in any size

disponibili su richiesta altre finiture ral / other ral finishes on request

disponibili su richiesta trattamenti di cataforesi e zincatura per zone marine  
cataphoresis and galvanizing treatments for marine areas are available on request

prodotto product	codice code	misura basamento base size	misura colonna column size	finitura finishing	altezza height	peso weight	prezzo price
jamaica	ft 015	mm	mm	ral	mm	kg	€
	ft 015	Ø450X10 450x450	Ø 40	black 9017 white 9016 antracite 7021 aluminium 9006 grey beige 7032	450 - 650	18	240
	ft 015	Ø450X10 450x450	Ø 40	black 9017 white 9016 antracite 7021 aluminium 9006 grey beige 7032	720	19	240
	ft 015	Ø450X10 450x450	Ø 40	black 9017 white 9016 antracite 7021 aluminium 9006 grey beige 7032	1100	21	266

prodotto product	codice code	misura basamento base size	misura colonna column size	finitura finishing	altezza height	peso weight	prezzo price
jamaica	ft 015	mm	mm	ral	mm	kg	€
	ft 015	Ø500X10 500x500	Ø 40	black 9017 white 9016 antracite 7021 aluminium 9006 grey beige 7032	450 - 650	20	246
	ft 015	Ø500X10 500x500	Ø 40	black 9017 white 9016 antracite 7021 aluminium 9006 grey beige 7032	720	21	246
	ft 015	Ø500X10 500x500	Ø 40	black 9017 white 9016 antracite 7021 aluminium 9006 grey beige 7032	1100	23	273

prodotto product	codice code	misura basamento base size	misura colonna column size	finitura finishing	altezza height	peso weight	prezzo price
jamaica	ft 015	mm	mm	ral	mm	kg	€
	ft 015	Ø600X10 600x600	Ø 40	black 9017 white 9016 antracite 7021 aluminium 9006 grey beige 7032	450 - 650	22	266
	ft 015	Ø600X10 600x600	Ø 40	black 9017 white 9016 antracite 7021 aluminium 9006 grey beige 7032	720	23	266
	ft 015	Ø600X10 600x600	Ø 40	black 9017 white 9016 antracite 7021 aluminium 9006 grey beige 7032	1100	25	293

basi tavolini / table bases

base tavolo in lamiera verniciato a polveri, piano tavolo in lamiera zincata  
table base in powder-coated sheet metal, table top in galvanized sheet metal

100% produzione italiana / 100% made in italy

su richiesta i basamenti sono disponibili in qualsiasi misura / on request, the bases are available in any size

disponibili su richiesta altre finiture ral / other ral finishes on request

disponibili su richiesta trattamenti di cataforesi e zincatura per zone marine  
cataphoresis and galvanizing treatments for marine areas are available on request

prodotto product	codice code	misura basamento base size	misura colonna column size	finitura finishing	altezza height	peso weight	prezzo price
cosmopolitan	ft/l	mm	mm	ral	mm	kg	€
	ft/l	600x600	30x30 - 40x40	black 9017 white 9016 antracite 7021 aluminium 9006 grey beige 7032	450 - 650	15	266
	ft/l	600x600	30x30 - 40x40	black 9017 white 9016 antracite 7021 aluminium 9006 grey beige 7032	720	16	280
	ft/l + bellini con poggiapiedi With footrest	600x600	30x30 - 40x40	black 9017 white 9016 antracite 7021 aluminium 9006 grey beige 7032	1100	18	400

prodotto product	codice code	misura basamento base size	misura colonna column size	finitura finishing	altezza height	peso weight	prezzo price
cosmopolitan	ft/l	mm	mm	ral	mm	kg	€
	ft/l	700X700	30x30 - 40x40	black 9017 white 9016 antracite 7021 aluminium 9006 grey beige 7032	450 - 650	17	280
	ft/l	700X700	30x30 - 40x40	black 9017 white 9016 antracite 7021 aluminium 9006 grey beige 7032	720	18	293
	ft/l + bellini con poggiapiedi With footrest	700X700	30x30 - 40x40	black 9017 white 9016 antracite 7021 aluminium 9006 grey beige 7032	1100	20	413

# cosmopolitan

verniciato a polveri / powder coated steel

prodotto product	codice code	misura basamento base size	misura colonna column size	finitura finishing	altezza height	peso weight	prezzo price
cosmopolitan	ft/l	mm	mm	ral	mm	kg	€
	ft/l	800X800	30x30 - 40x40	black 9017 white 9016 antracite 7021 aluminium 9006 grey beige 7032	450 - 650	20	360
	ft/l	800X800	30x30 - 40x40	black 9017 white 9016 antracite 7021 aluminium 9006 grey beige 7032	720	22	373
	ft/l + bellini con poggiapiedi With footrest	800X800	30x30 - 40x40	black 9017 white 9016 antracite 7021 aluminium 9006 grey beige 7032	1100	24	493

prodotto product	codice code	misura basamento base size	misura colonna column size	finitura finishing	altezza height	peso weight	prezzo price
cosmopolitan	ft/l	mm	mm	ral	mm	kg	€
	ft/l	900X900	30x30 - 40x40	black 9017 white 9016 antracite 7021 aluminium 9006 grey beige 7032	450 - 650	16	386
	ft/l	900X900	30x30 - 40x40	black 9017 white 9016 antracite 7021 aluminium 9006 grey beige 7032	720	17	400
	ft/l + bellini con poggiapiedi With footrest	900X900	30x30 - 40x40	black 9017 white 9016 antracite 7021 aluminium 9006 grey beige 7032	1100	19	520

prodotto product	codice code	misura basamento base size	misura colonna column size	finitura finishing	altezza height	peso weight	prezzo price
cosmopolitan	ft/l	mm	mm	ral	mm	kg	€
	ft/l	1000X1000	30x30 - 40x40	black 9017 white 9016 antracite 7021 aluminium 9006 grey beige 7032	450 - 650	17	453
	ft/l	1000X1000	30x30 - 40x40	black 9017 white 9016 antracite 7021 aluminium 9006 grey beige 7032	720	18	466
	ft/l + bellini con poggiapiedi With footrest	1000X1000	30x30 - 40x40	black 9017 white 9016 antracite 7021 aluminium 9006 grey beige 7032	1100	20	586

# cosmopolitan

verniciato a polveri / powder coated steel

prodotto product	codice code	misura basamento base size	misura colonna column size	finitura finishing	altezza height	peso weight	prezzo price
cosmopolitan	ft/l	mm	mm	ral	mm	kg	€
	ft/l	1200X800	30x30 - 40x40	black 9017 white 9016 antracite 7021 aluminium 9006 grey beige 7032	450 - 650	28	460
	ft/l	1200X800	30x30 - 40x40	black 9017 white 9016 antracite 7021 aluminium 9006 grey beige 7032	720	29	473
	ft/l + bellini con poggiapiedi With footrest	1200X800	30x30 - 40x40	black 9017 white 9016 antracite 7021 aluminium 9006 grey beige 7032	1100	31	620

prodotto product	codice code	misura basamento base size	misura colonna column size	finitura finishing	altezza height	peso weight	prezzo price
cosmopolitan	ft/l	mm	mm	ral	mm	kg	€
	ft/l	1400X800	30x30 - 40x40	black 9017 white 9016 antracite 7021 aluminium 9006 grey beige 7032	450 - 650	28	480
	ft/l	1400X800	30x30 - 40x40	black 9017 white 9016 antracite 7021 aluminium 9006 grey beige 7032	720	29	501
	ft/l + bellini con poggiapiedi With footrest	1400X800	30x30 - 40x40	black 9017 white 9016 antracite 7021 aluminium 9006 grey beige 7032	1100	31	650

prodotto product	codice code	misura basamento base size	misura colonna column size	finitura finishing	altezza height	peso weight	prezzo price
cosmopolitan	ft/l	mm	mm	ral	mm	kg	€
	ft/l	1600X900	40X40	black 9017 white 9016 antracite 7021 aluminium 9006 grey beige 7032	450 - 650	35	520
	ft/l	1600X900	40X40	black 9017 white 9016 antracite 7021 aluminium 9006 grey beige 7032	720	36	533
	ft/l + bellini con poggiapiedi With footrest	1600X900	40X40	black 9017 white 9016 antracite 7021 aluminium 9006 grey beige 7032	1100	38	713

prodotto product	codice code	misura basamento base size	misura colonna column size	finitura finishing	altezza height	peso weight	prezzo price
cosmopolitan	ft/l	mm	mm	ral	mm	kg	€
	ft/l	1800X800	40X40	black 9017 white 9016 antracite 7021 aluminium 9006 grey beige 7032	450 - 650	39	573
	ft/l	1800X800	40X40	black 9017 white 9016 antracite 7021 aluminium 9006 grey beige 7032	720	40	600
	ft/l + bellini con poggiatesta With footrest	1800X800	40X40	black 9017 white 9016 antracite 7021 aluminium 9006 grey beige 7032	1100	42	780

prodotto product	codice code	misura basamento base size	misura colonna column size	finitura finishing	altezza height	peso weight	prezzo price
cosmopolitan	ft/l	mm	mm	ral	mm	kg	€
	ft/l	2000x800	40X40	black 9017 white 9016 antracite 7021 aluminium 9006 grey beige 7032	450 - 650	40	626
	ft/l	2000x800	60X60 - 80X80	black 9017 white 9016 antracite 7021 aluminium 9006 grey beige 7032	720	45	640
	ft/l + bellini con poggiatesta With footrest	2000x800	60X60 - 80X80	black 9017 white 9016 antracite 7021 aluminium 9006 grey beige 7032	1100	47	873

prodotto product	codice code	misura basamento base size	misura colonna column size	finitura finishing	altezza height	peso weight	prezzo price
cosmopolitan	ft/l	mm	mm	ral	mm	kg	€
	ft/l	2500x1000	40X40	black 9017 white 9016 antracite 7021 aluminium 9006 grey beige 7032	720	60	773
	ft/l + bellini con poggiatesta With footrest	2500x1000	40X40	black 9017 white 9016 antracite 7021 aluminium 9006 grey beige 7032	1100	62	980



sgabelli / stool - tavolino/ small table

sgabello/tavolino in metallo verniciato - seduta in lamiera zincata  
stool/small table in painted metal / seat in galvanized sheet metal

100% produzione italiana / 100% made in italy

disponibili su richiesta altre finiture ral / other ral finishes on request  
disponibili con seduta in hpl / available with hpl seat

disponibili su richiesta trattamenti di cataforesi e zincatura per zone marine  
cataphoresis and galvanizing treatments for marine areas are available on request

prodotto product	codice code	misura basamento base size	misura colonna column size	finitura finishing	altezza height	peso weight	prezzo price
bellini	bellini	mm	mm	ral	mm	kg	€
	bellini	36X36	25X25	black 9017 white 9016 antracite 7021 aluminium 9006 grey beige 7032	750	7	166
	bellini	36X36	25X25	black 9017 white 9016 antracite 7021 aluminium 9006 grey beige 7032	450	5	133





sgabelli / stool - tavolino/ small table

sgabello/tavolino in metallo verniciato - seduta in lamiera zincata  
stool/small table in painted metal / seat in galvanized sheet metal

100% produzione italiana / 100% made in italy

disponibili su richiesta altre finiture ral / other ral finishes on request  
disponibili con seduta in hpl / available with hpl seat

disponibili su richiesta trattamenti di cataforesi e zincatura per zone marine  
cataphoresis and galvanizing treatments for marine areas are available on request

prodotto product	codice code	misura basamento base size	misura colonna column size	finitura finishing	altezza height	peso weight	prezzo price
gin	gin	mm	mm	ral	mm	kg	€
	gin	36X36	20X20	black 9017 white 9016 antracite 7021 aluminium 9006 grey beige 7032	400	6	146
	gin	36X36	20X20	black 9017 white 9016 antracite 7021 aluminium 9006 grey beige 7032	500	8	160
	gin	36X36	20X20	black 9017 white 9016 antracite 7021 aluminium 9006 grey beige 7032	600	10	173

basi tavolini / table bases

struttura tavolo escluso top / table base without table top.

100% produzione italiana / 100% made in italy

disponibili su richiesta altre finiture ral / other ral finishes on request

disponibili su richiesta trattamenti di cataforesi e zincatura per zone marine  
cataphoresis and galvanizing treatments for marine areas are available on request

prodotto product	codice code	misura basamento base size	misura colonna column size	finitura finishing	altezza height	peso weight	prezzo price
florida	ft 044 - ft 025	mm	mm	ral	mm	kg	€
	ft 044 - ft 025	600x600	30x30 - 40x40 - Ø 50	black 9017 white 9016 antracite 7021 aluminium 9006 grey beige 7032	450 - 650	8	172
	ft 044 - ft 025	600x600	30x30 - 40x40 - Ø 50	black 9017 white 9016 antracite 7021 aluminium 9006 grey beige 7032	720	9	172
	ft 044 - ft 025 - bellini con poggiatesta with footrest	600x600	30x30 - 40x40 - Ø 50	black 9017 white 9016 antracite 7021 aluminium 9006 grey beige 7032	1100 poggiatesta footrest	11	272

prodotto product	codice code	misura basamento base size	misura colonna column size	finitura finishing	altezza height	peso weight	prezzo price
florida	ft 044 - ft 025	mm	mm	ral	mm	kg	€
	ft 044 - ft 025	700x700	30x30 - 40x40 - Ø 50	black 9017 white 9016 antracite 7021 aluminium 9006 grey beige 7032	450 - 650	9	172
	ft 044 - ft 025	700x700	30x30 - 40x40 - Ø 50	black 9017 white 9016 antracite 7021 aluminium 9006 grey beige 7032	720	10	172
	ft 044 - ft 025 - bellini con poggiatesta with footrest	700x700	30x30 - 40x40 - Ø 50	black 9017 white 9016 antracite 7021 aluminium 9006 grey beige 7032	1100 poggiatesta footrest	12	272



# florida/florida-round

verniciato a polveri / powder coated steel

prodotto product	codice code	misura basamento base size	misura colonna column size	finitura finishing	altezza height	peso weight	prezzo price
florida	ft 044 - ft 025	mm	mm	ral	mm	kg	€
	ft 044 - ft 025	800x800	30x30 - 40x40 - Ø 50	black 9017 white 9016 antracite 7021 aluminium 9006 grey beige 7032	450 - 650	10	177
	ft 044 - ft 025	800x800	30x30 - 40x40 - Ø 50	black 9017 white 9016 antracite 7021 aluminium 9006 grey beige 7032	720	11	177
	ft 044 - ft 025 - bellini con poggiapiedi with footrest	800x800	30x30 - 40x40 - Ø 50	black 9017 white 9016 antracite 7021 aluminium 9006 grey beige 7032	1100 poggiapiedi footrest	13	277

prodotto product	codice code	misura basamento base size	misura colonna column size	finitura finishing	altezza height	peso weight	prezzo price
florida	ft 044 - ft 025	mm	mm	ral	mm	kg	€
	ft 044 - ft 025	900x900	30x30 - 40x40 - Ø 50	black 9017 white 9016 antracite 7021 aluminium 9006 grey beige 7032	450 - 650	11	183
	ft 044 - ft 025	900x900	30x30 - 40x40 - Ø 50	black 9017 white 9016 antracite 7021 aluminium 9006 grey beige 7032	720	12	183
	ft 044 - ft 025 - bellini con poggiapiedi with footrest	900x900	30x30 - 40x40 - Ø 50	black 9017 white 9016 antracite 7021 aluminium 9006 grey beige 7032	1100 poggiapiedi footrest	14	283

prodotto product	codice code	misura basamento base size	misura colonna column size	finitura finishing	altezza height	peso weight	prezzo price
florida	ft 044 - ft 025	mm	mm	ral	mm	kg	€
	ft 044 - ft 025	1200x800	30x30 - 40x40 - Ø 50	black 9017 white 9016 antracite 7021 aluminium 9006 grey beige 7032	450 - 650	12	211
	ft 044 - ft 025	1200x800	30x30 - 40x40 - Ø 50	black 9017 white 9016 antracite 7021 aluminium 9006 grey beige 7032	720	13	211
	ft 044 - ft 025 - bellini con poggiapiedi with footrest	1200x800	30x30 - 40x40 - Ø 50	black 9017 white 9016 antracite 7021 aluminium 9006 grey beige 7032	1100 poggiapiedi footrest	16	333

# florida/florida-round

verniciato a polveri / powder coated steel

prodotto product	codice code	misura basamento base size	misura colonna column size	finitura finishing	altezza height	peso weight	prezzo price
florida	ft 044 - ft 025	mm	mm	ral	mm	kg	€
	ft 044 - ft 025	1600x800	30x30 - 40x40 - Ø 50	black 9017 white 9016 antracite 7021 aluminium 9006 grey beige 7032	450 - 650	13	222
	ft 044 - ft 025	1600x800	30x30 - 40x40 - Ø 50	black 9017 white 9016 antracite 7021 aluminium 9006 grey beige 7032	720	14	222
	ft 044 - ft 025 - bellini con poggiapiedi with footrest	1600x800	30x30 - 40x40 - Ø 50	black 9017 white 9016 antracite 7021 aluminium 9006 grey beige 7032	1100 poggiapiedi footrest	16	372

prodotto product	codice code	misura basamento base size	misura colonna column size	finitura finishing	altezza height	peso weight	prezzo price
florida	ft 044 - ft 025	mm	mm	ral	mm	kg	€
	ft 044 - ft 025	1800x900	30x30 - 40x40 - Ø 50	black 9017 white 9016 antracite 7021 aluminium 9006 grey beige 7032	450 - 650	14	255
	ft 044 - ft 025	1800x900	30x30 - 40x40 - Ø 50	black 9017 white 9016 antracite 7021 aluminium 9006 grey beige 7032	720	15	255
	ft 044 - ft 025 - bellini con poggiapiedi with footrest	1800x900	40x40 - Ø 50	black 9017 white 9016 antracite 7021 aluminium 9006 grey beige 7032	1100 poggiapiedi footrest	18	405

prodotto product	codice code	misura basamento base size	misura colonna column size	finitura finishing	altezza height	peso weight	prezzo price
florida	ft 044 - ft 025	mm	mm	ral	mm	kg	€
	ft 044 - ft 025	2200x800	30x30 - 40x40 - Ø 50	black 9017 white 9016 antracite 7021 aluminium 9006 grey beige 7032	450 - 650	18	388
	ft 044 - ft 025	2200x800	30x30 - 40x40 - Ø 50	black 9017 white 9016 antracite 7021 aluminium 9006 grey beige 7032	720	20	388
	ft 044 - ft 025 - bellini con poggiapiedi with footrest	2200x800	40x40 - Ø 50	black 9017 white 9016 antracite 7021 aluminium 9006 grey beige 7032	1100 poggiapiedi footrest	24	583

prodotto product	codice code	misura basamento base size	misura colonna column size	finitura finishing	altezza height	peso weight	prezzo price
florida	ft 044 - ft 025	mm	mm	ral	mm	kg	€
	ft 044 - ft 025	2500x1000	30x30 - 40x40 - Ø 50	black 9017 white 9016 antracite 7021 aluminium 9006 grey beige 7032	450 - 650	20	488
	ft 044 - ft 025	2500x1000	30x30 - 40x40 - Ø 50	black 9017 white 9016 antracite 7021 aluminium 9006 grey beige 7032	720	22	488
	ft 044 - ft 025 - bellini con poggiatesta with footrest	2500x1000	40x40 - Ø 50	black 9017 white 9016 antracite 7021 aluminium 9006 grey beige 7032	1100 poggiatesta footrest	25	683

basi tavolini / table bases

acciaio inox aisi 316 / inox steel aisi 316

struttura tavolo escluso top / table base without table top.

100% produzione italiana / 100% made in italy

disponibili su richiesta altre finiture ral / other ral finishes on request  
disponibili con seduta in hpl / available with hpl seat

prodotto product	codice code	misura basamento base size	misura colonna column size	finitura finishing	altezza height	peso weight	prezzo price
florida	ft 044	mm	mm	inox	mm	kg	€
	ft 044	800x800	40x40	aisi 316	450 - 650	21	433
	ft 044	800x800	40x40	aisi 316	720	23	433
	ft 044 con poggiatesta with footrest	800x800	40x40	aisi 316	1100 poggiatesta footrest	26	500

prodotto product	codice code	misura basamento base size	misura colonna column size	finitura finishing	altezza height	peso weight	prezzo price
florida	ft 044	mm	mm	inox	mm	kg	€
	ft 044	1200x800	40x40	aisi 316	450 - 650	23	444
	ft 044	1200x800	40x40	aisi 316	720	25	444
	ft 044 con poggiatesta with footrest	1200x800	40x40	aisi 316	1100 poggiatesta footrest	28	522

prodotto product	codice code	misura basamento base size	misura colonna column size	finitura finishing	altezza height	peso weight	prezzo price
florida	ft 044	mm	mm	inox	mm	kg	€
	ft 044	1500x800	40x40	aisi 316	450 - 650	21	477
	ft 044	1500x800	40x40	aisi 316	720	23	477
	ft 044 con poggiatesta with footrest	1500x800	40x40	aisi 316	1100 poggiatesta footrest	26	533

# florida inox 316/verniciato

prodotto product	codice code	misura basamento base size	misura colonna column size	finitura finishing	altezza height	peso weight	prezzo price
florida	ft 044	mm	mm	inox + ral	mm	kg	€
	ft 044	800x800	40x40	black 9017 white 9016 antracite 7021 aluminium 9006 grey beige 7032	450 - 650	21	422
	ft 044	800x800	40x40	black 9017 white 9016 antracite 7021 aluminium 9006 grey beige 7032	720	23	422
	ft 044 con poggiatesta with footrest	800x800	40x40	black 9017 white 9016 antracite 7021 aluminium 9006 grey beige 7032	1100 poggiatesta footrest	26	477

prodotto product	codice code	misura basamento base size	misura colonna column size	finitura finishing	altezza height	peso weight	prezzo price
florida	ft 044	mm	mm	inox + ral	mm	kg	€
	ft 044	1200x800	40x40	black 9017 white 9016 antracite 7021 aluminium 9006 grey beige 7032	450 - 650	23	433
	ft 044	1200x800	40x40	black 9017 white 9016 antracite 7021 aluminium 9006 grey beige 7032	720	25	433
	ft 044 con poggiatesta with footrest	1200x800	40x40	black 9017 white 9016 antracite 7021 aluminium 9006 grey beige 7032	1100 poggiatesta footrest	28	488

prodotto product	codice code	misura basamento base size	misura colonna column size	finitura finishing	altezza height	peso weight	prezzo price
florida	ft 044	mm	mm	inox + ral	mm	kg	€
	ft 044	1500x800	40x40	black 9017 white 9016 antracite 7021 aluminium 9006 grey beige 7032	450 - 650	21	466
	ft 044	1500x800	40x40	black 9017 white 9016 antracite 7021 aluminium 9006 grey beige 7032	720	23	466
	ft 044 con poggiatesta with footrest	1500x800	40x40	black 9017 white 9016 antracite 7021 aluminium 9006 grey beige 7032	1100 poggiatesta footrest	26	522

# bahia

verniciato a polveri / powder coated steel

basi tavolini / table bases

struttura tavolo escluso top / table base without table top.

100% produzione italiana / 100% made in italy

disponibili su richiesta altre finiture ral / other ral finishes on request

disponibili su richiesta trattamenti di cataforesi e zincatura per zone marine  
cathaphoresis and galvanizing treatments for marine areas are available on request

prodotto product	codice code	misura basamento base size	misura colonna column size	finitura finishing	altezza height	peso weight	prezzo price
bahia	bahia	mm	mm	ral	mm	kg	€
	bahia	600x600	60X30	black 9017 white 9016 antracite 7021 aluminium 9006 grey beige 7032	450 - 650	8	166
	bahia	600x600	60X30	black 9017 white 9016 antracite 7021 aluminium 9006 grey beige 7032	720	9	172

prodotto product	codice code	misura basamento base size	misura colonna column size	finitura finishing	altezza height	peso weight	prezzo price
bahia	bahia	mm	mm	ral	mm	kg	€
	bahia	700x700	60X30	black 9017 white 9016 antracite 7021 aluminium 9006 grey beige 7032	450 - 650	9	166
	bahia	700x700	60X30	black 9017 white 9016 antracite 7021 aluminium 9006 grey beige 7032	720	10	172

prodotto product	codice code	misura basamento base size	misura colonna column size	finitura finishing	altezza height	peso weight	prezzo price
bahia	bahia	mm	mm	ral	mm	kg	€
	bahia	800x800	60X30	black 9017 white 9016 antracite 7021 aluminium 9006 grey beige 7032	450 - 650	10	172
	bahia	800x800	60X30	black 9017 white 9016 antracite 7021 aluminium 9006 grey beige 7032	720	11	177

prodotto product	codice code	misura basamento base size	misura colonna column size	finitura finishing	altezza height	peso weight	prezzo price
bahia	bahia	mm	mm	ral	mm	kg	€
	bahia	900x900	60X30	black 9017 white 9016 antracite 7021 aluminium 9006 grey beige 7032	450 - 650	11	177
	bahia	900x900	60X30	black 9017 white 9016 antracite 7021 aluminium 9006 grey beige 7032	720	12	183

prodotto product	codice code	misura basamento base size	misura colonna column size	finitura finishing	altezza height	peso weight	prezzo price
bahia	bahia	mm	mm	ral	mm	kg	€
	bahia	1200x800	60X30	black 9017 white 9016 antracite 7021 aluminium 9006 grey beige 7032	450 - 650	12	205
	bahia	1200x800	60X30	black 9017 white 9016 antracite 7021 aluminium 9006 grey beige 7032	720	13	211

prodotto product	codice code	misura basamento base size	misura colonna column size	finitura finishing	altezza height	peso weight	prezzo price
bahia	bahia	mm	mm	ral	mm	kg	€
	bahia	1600x800	60X30	black 9017 white 9016 antracite 7021 aluminium 9006 grey beige 7032	450 - 650	13	216
	bahia	1600x800	60X30	black 9017 white 9016 antracite 7021 aluminium 9006 grey beige 7032	720	14	222

prodotto product	codice code	misura basamento base size	misura colonna column size	finitura finishing	altezza height	peso weight	prezzo price
bahia	bahia	mm	mm	ral	mm	kg	€
	bahia	1800x900	60X30	black 9017 white 9016 antracite 7021 aluminium 9006 grey beige 7032	450 - 650	14	250
	bahia	1800x900	60X30	black 9017 white 9016 antracite 7021 aluminium 9006 grey beige 7032	720	15	255

prodotto product	codice code	misura basamento base size	misura colonna column size	finitura finishing	altezza height	peso weight	prezzo price
bahia	bahia	mm	mm	ral	mm	kg	€
	bahia	2200x800	60X30	black 9017 white 9016 antracite 7021 aluminium 9006 grey beige 7032	450 - 650	18	305
	bahia	2200x800	60X30	black 9017 white 9016 antracite 7021 aluminium 9006 grey beige 7032	720	20	311

prodotto product	codice code	misura basamento base size	misura colonna column size	finitura finishing	altezza height	peso weight	prezzo price
bahia	bahia	mm	mm	ral	mm	kg	€
	bahia	2500x1000	60X30	black 9017 white 9016 antracite 7021 aluminium 9006 grey beige 7032	450 - 650	20	327
	bahia	2500x1000	60X30	black 9017 white 9016 antracite 7021 aluminium 9006 grey beige 7032	720	22	333

# manhattan

verniciato a polveri / powder coated steel

basi tavolini / table bases

struttura tavolo escluso top / table base without table top

100% produzione italiana / 100% made in italy

disponibili su richiesta altre finiture ral / other ral finishes on request

disponibili su richiesta trattamenti di cataforesi e zincatura per zone marine  
cataphoresis and galvanizing treatments for marine areas are available on request

prodotto product	codice code	misura basamento base size	misura colonna column size	finitura finishing	altezza height	peso weight	prezzo price
manhattan	manhattan	mm	mm	ral	mm	kg	€
	manhattan	800x800	40x40	black 9017 white 9016 antracite 7021 aluminium 9006 grey beige 7032	450 - 650	15	235
	manhattan	800x800	40x40	black 9017 white 9016 antracite 7021 aluminium 9006 grey beige 7032	720	16	250
	manhattan	800x800	40x40	black 9017 white 9016 antracite 7021 aluminium 9006 grey beige 7032	1100	18	311

prodotto product	codice code	misura basamento base size	misura colonna column size	finitura finishing	altezza height	peso weight	prezzo price
manhattan	manhattan	mm	mm	ral	mm	kg	€
	manhattan	900x900	40x40	black 9017 white 9016 antracite 7021 aluminium 9006 grey beige 7032	450 - 650	16	255
	manhattan	900x900	40x40	black 9017 white 9016 antracite 7021 aluminium 9006 grey beige 7032	720	17	267
	manhattan	900x900	40x40	black 9017 white 9016 antracite 7021 aluminium 9006 grey beige 7032	1100	20	327

# manhattan

verniciato a polveri / powder coated steel

prodotto product	codice code	misura basamento base size	misura colonna column size	finitura finishing	altezza height	peso weight	prezzo price
manhattan	manhattan	mm	mm	ral	mm	kg	€
	manhattan	1200x800	60x30	black 9017 white 9016 antracite 7021 aluminium 9006 grey beige 7032	450 - 650	17	377
	manhattan	1200x800	60x30	black 9017 white 9016 antracite 7021 aluminium 9006 grey beige 7032	720	19	389
	manhattan	1200x800	60x30	black 9017 white 9016 antracite 7021 aluminium 9006 grey beige 7032	1100	22	422

prodotto product	codice code	misura basamento base size	misura colonna column size	finitura finishing	altezza height	peso weight	prezzo price
manhattan	manhattan	mm	mm	ral	mm	kg	€
	manhattan	1600x800	60x30	black 9017 white 9016 antracite 7021 aluminium 9006 grey beige 7032	450 - 650	20	433
	manhattan	1600x800	60x30	black 9017 white 9016 antracite 7021 aluminium 9006 grey beige 7032	720	22	445
	manhattan	1600x800	60x30	black 9017 white 9016 antracite 7021 aluminium 9006 grey beige 7032	1100	25	477

prodotto product	codice code	misura basamento base size	misura colonna column size	finitura finishing	altezza height	peso weight	prezzo price
manhattan	manhattan	mm	mm	ral	mm	kg	€
	manhattan	1800x800	60x30	black 9017 white 9016 antracite 7021 aluminium 9006 grey beige 7032	450 - 650	20	455
	manhattan	1800x800	60x30	black 9017 white 9016 antracite 7021 aluminium 9006 grey beige 7032	720	23	467
	manhattan	1800x800	60x30	black 9017 white 9016 antracite 7021 aluminium 9006 grey beige 7032	1100	26	500

# manhattan

verniciato a polveri / powder coated steel

prodotto product	codice code	misura basamento base size	misura colonna column size	finitura finishing	altezza height	peso weight	prezzo price
manhattan	manhattan	mm	mm	ral	mm	kg	€
	manhattan	2200x800	100x30	black 9017 white 9016 antracite 7021 aluminium 9006 grey beige 7032	450 - 650	22	545
	manhattan	2200x800	100x30	black 9017 white 9016 antracite 7021 aluminium 9006 grey beige 7032	720	25	555
	manhattan	2200x800	100x30	black 9017 white 9016 antracite 7021 aluminium 9006 grey beige 7032	1100	27	611

prodotto product	codice code	misura basamento base size	misura colonna column size	finitura finishing	altezza height	peso weight	prezzo price
manhattan	manhattan	mm	mm	ral	mm	kg	€
	manhattan	2500x800	100X30	black 9017 white 9016 antracite 7021 aluminium 9006 grey beige 7032	450 - 650	23	600
	manhattan	2500x800	100X30	black 9017 white 9016 antracite 7021 aluminium 9006 grey beige 7032	720	26	611
	manhattan	2500x800	100X30	black 9017 white 9016 antracite 7021 aluminium 9006 grey beige 7032	1100	28	670

# comfort s/p

verniciato a polveri / powder coated steel

## comfort s

sgabello / stool

struttura in acciaio AISI 316 con top in HPL / AISI 316 steel structure with HPL top

100% produzione italiana / 100% made in italy

disponibili su richiesta altre finiture ral / other ral finishes on request

disponibili su richiesta trattamenti di cataforesi e zincatura per zone marine  
cataphoresis and galvanizing treatments for marine areas are available on request

## comfort p

panca / bench

struttura in acciaio AISI 316 con top in HPL / AISI 316 steel structure with HPL top

100% produzione italiana / 100% made in italy

disponibili su richiesta altre finiture ral / other ral finishes on request

disponibili su richiesta trattamenti di cataforesi e zincatura per zone marine  
cataphoresis and galvanizing treatments for marine areas are available on request

prodotto product	codice code	misura basamento base size	misura colonna column size	finitura finishing	altezza height	peso weight	prezzo price
comfort s	comfort s	mm	mm	ral	mm	kg	€
	comfort s	su richiesta on request	su richiesta on request	black 9017 white 9016 antracite 7021 aluminium 9006 grey beige 7032	su richiesta on request	/	/

prodotto product	codice code	misura basamento base size	misura colonna column size	finitura finishing	altezza height	peso weight	prezzo price
comfort p	comfort p	mm	mm	ral	mm	kg	€
	comfort p	su richiesta on request	su richiesta on request	black 9017 white 9016 antracite 7021 aluminium 9006 grey beige 7032	su richiesta on request	/	/



basi tavolini / table bases

base tavolo 4 razze verniciato a polveri, piastra per fissaggio piano, con piedini regolabili - piano in lamiera zincata  
table base 4 feet powder coated, plate support for table top, with adjustable feet - top in galvanized sheet metal

100% produzione italiana / 100% made in italy

disponibili su richiesta altre finiture ral / other ral finishes on request

disponibili su richiesta trattamenti di cataforesi e zincatura per zone marine  
cataphoresis and galvanizing treatments for marine areas are available on request

prodotto product	codice code	misura basamento base size	misura colonna column size	finitura finishing	altezza height	peso weight	prezzo price
tulip	tulip	mm	mm	ral	mm	kg	€
	tulip	Ø 800	Ø 40	black 9017 white 9016 antracite 7021 aluminium 9006 grey beige 7032	720	25	400
	tulip	Ø 1000	Ø 40	black 9017 white 9016 antracite 7021 aluminium 9006 grey beige 7032	720	35	450

# margarita square/round

verniciato a polveri / powder coated steel

basi tavolini / table bases

base tavolo 4 gambe vernicato a polveri  
table base 4 feet powder coated

100% produzione italiana / 100% made in italy

disponibili su richiesta altre finiture ral / other ral finishes on request

disponibili su richiesta trattamenti di cataforesi e zincatura per zone marine  
cataphoresis and galvanizing treatments for marine areas are available on request

prodotto product	codice code	misura basamento base size	misura colonna column size	finitura finishing	altezza height	peso weight	prezzo price
jakie square	jakie square	mm	mm	ral	mm	kg	€
	margarita square	700x700	Ø 40	black 9017 white 9016 antracite 7021 aluminium 9006 grey beige 7032	720	10	320
	margarita square	800x800	Ø 40	black 9017 white 9016 antracite 7021 aluminium 9006 grey beige 7032	720	12	360
	margarita square	900x900	Ø 40	black 9017 white 9016 antracite 7021 aluminium 9006 grey beige 7032	720	14	380

prodotto product	codice code	misura basamento base size	misura colonna column size	finitura finishing	altezza height	peso weight	prezzo price
jakie round	jakie round	mm	mm	ral	mm	kg	€
	margarita round	Ø 700	Ø 40	black 9017 white 9016 antracite 7021 aluminium 9006 grey beige 7032	720	10	260
	margarita round	Ø 800	Ø 40	black 9017 white 9016 antracite 7021 aluminium 9006 grey beige 7032	720	12	290
	margarita round	Ø 900	Ø 40	black 9017 white 9016 antracite 7021 aluminium 9006 grey beige 7032	720	14	310

# paloma

verniciato a polveri / powder coated steel

basi tavolini / table bases

base tavolo 4 gambe vernicato a polveri  
table base 4 feet powder coated

100% produzione italiana / 100% made in italy

disponibili su richiesta altre finiture ral / other ral finishes on request

disponibili su richiesta trattamenti di cataforesi e zincatura per zone marine  
cataphoresis and galvanizing treatments for marine areas are available on request

prodotto product	codice code	misura basamento base size	finitura finishing	altezza height	peso weight	prezzo price
blade	blade	mm	ral	mm	kg	€
	paloma	700x700	black 9017 white 9016 antracite 7021 aluminium 9006 grey beige 7032	720	10	250
	paloma	800x800	black 9017 white 9016 antracite 7021 aluminium 9006 grey beige 7032	720	12	300
	paloma	900x900	black 9017 white 9016 antracite 7021 aluminium 9006 grey beige 7032	720	14	350

# kube

verniciato a polveri / powder coated steel

basi tavolini / table bases

100% produzione italiana / 100% made in italy

disponibili su richiesta altre finiture ral / other ral finishes on request

disponibili su richiesta trattamenti di cataforesi e zincatura per zone marine  
cataphoresis and galvanizing treatments for marine areas are available on request

prodotto product	codice code	misura basamento base size	finitura finishing	altezza height	peso weight	prezzo price
kube	kube	mm	ral	mm	kg	€
	kube	360x360	black 9017 white 9016 antracite 7021 aluminium 9006 grey beige 7032	360	10	410

basi tavolini / table bases

base tavolo 4 razze vernicato a polveri in ghisa, colonna in alluminio - piastra per fissaggio piano sistema pieghevole - con piedini regolabili

table base cast iron 4 feet powder coated, column aluminium - plate support for table top with tip-up system - with adjustable feet

100% produzione europea / 100% made in europe

disponibili su richiesta altre finiture ral / other ral finishes on request

prodotto product	codice code	misura basamento base size	misura colonna column size	finitura finishing	altezza height	peso weight	prezzo price
dakota	ft 711	mm	mm	ral	mm	kg	€
	ft 711	450X450	Ø 60	black 9017 white 9016 antracite 7021 aluminium 9006 grey beige 7032	450 - 650	7	200
	ft 711	450X450	Ø 60	black 9017 white 9016 antracite 7021 aluminium 9006 grey beige 7032	720	7	200
	ft 711	450X450	Ø 60	black 9017 white 9016 antracite 7021 aluminium 9006 grey beige 7032	1100	7	225

prodotto product	codice code	misura basamento base size	misura colonna column size	finitura finishing	altezza height	peso weight	prezzo price
dakota	ft 711 double	mm	mm	ral	mm	kg	€
	ft 711 double	500x900	Ø 60	black 9017 white 9016 antracite 7021 aluminium 9006 grey beige 7032	450 - 650	12	270
	ft 711 double	500x900	Ø 60	black 9017 white 9016 antracite 7021 aluminium 9006 grey beige 7032	720	14	270
	ft 711 double	500x900	Ø 60	black 9017 white 9016 antracite 7021 aluminium 9006 grey beige 7032	1100	18	300

basi tavolini / table bases

base tavolo 4 razze vernicato a polveri in ghisa, colonna in metallo - piastra per fissaggio piano - con piedini regolabili

table base cast iron 4 feet powder coated, metal column - plate support for table top - with adjustable feet

100% produzione europea / 100% made in europe

disponibili su richiesta altre finiture ral / other ral finishes on request

prodotto product	codice code	misura basamento base size	misura colonna column size	finitura finishing	altezza height	peso weight	prezzo price
ft 713	ft 713	mm	mm	ral	mm	kg	€
	ft 713	550x550	Ø 80	black 9017 white 9016 antracite 7021 aluminium 9006 grey beige 7032	450 - 650	9	150
	ft 713	550x550	Ø 80	black 9017 white 9016 antracite 7021 aluminium 9006 grey beige 7032	720	9	150
	ft 713	550x550	Ø 80	black 9017 white 9016 antracite 7021 aluminium 9006 grey beige 7032	1100	9	165

basi tavolini / table bases

base tavolo 4 razze in metallo verniciato a polveri, piastra per fissaggio piano - con piedini regolabili  
table base cast iron 4 feet powder coated, column painted cast iron, plate support for table top - with adjustable feet

100% produzione italiana / 100% made in italy

disponibili su richiesta altre finiture ral / other ral finishes on request

disponibilità basamenti su richiesta per piani rettangolari / bases available on request for rectangular tops

disponibili su richiesta trattamenti di cataforesi e zincatura per zone marine  
cataphoresis and galvanizing treatments for marine areas are available on request

prodotto product	codice code	misura basamento base size	misura colonna column size	finitura finishing	altezza height	peso weight	prezzo price
nippon	ft 022	mm	mm	ral	mm	kg	€
	ft 022	450x450	Ø 60 - Ø 80	black 9017 white 9016 antracite 7021 aluminium 9006 grey beige 7032	450 - 650	8,5	226
	ft 022	450x450	Ø 60 - Ø 80	black 9017 white 9016 antracite 7021 aluminium 9006 grey beige 7032	720	8,5	226
	ft 022	450x450	Ø 60 - Ø 80	black 9017 white 9016 antracite 7021 aluminium 9006 grey beige 7032	1100	8,5	260

tavolino - small table

tavolino in metallo verniciato - piano in lamiera zincata / coffee table - top in galvanized sheet metal

100% produzione italiana / 100% made in italy

su richiesta i basamenti sono disponibili in qualsiasi misura / on request, the bases are available in any size

disponibili su richiesta altre finiture ral / other ral finishes on request

disponibili su richiesta trattamenti di cataforesi e zincatura per zone marine  
cataphoresis and galvanizing treatments for marine areas are available on request

prodotto product	codice code	misura basamento base size	misura colonna column size	finitura finishing	altezza height	peso weight	prezzo price
daiquiri	daiquiri	mm	mm	ral	mm	kg	€
	daiquiri	30X30 - 40X40 Ø 300 - Ø 400	40X40 - Ø 60	black 9017 white 9016 antracite 7021 aluminium 9006 grey beige 7032	450 - 650	10	160

tavolino - small table

base tavolino in metallo verniciato / table base

100% produzione italiana / 100% made in italy

su richiesta i basamenti sono disponibili in qualsiasi misura / on request, the bases are available in any size

applicazione piano hpl su richiesta / application ton hpl on request

disponibili su richiesta altre finiture ral / other ral finishes on request

disponibili su richiesta trattamenti di cataforesi e zincatura per zone marine  
cataphoresis and galvanizing treatments for marine areas are available on request

prodotto product	codice code	misura basamento base size	misura colonna column size	finitura finishing	altezza height	peso weight	prezzo price
daiquiri	daiquiri	mm	mm	ral	mm	kg	€
	daiquiri	30X30 - 40X40 Ø 300 - Ø 400	40X40 - Ø 60	black 9017 white 9016 antracite 7021 aluminium 9006 grey beige 7032	450 - 650	12	135

# cuba-libre

tavolino - small table

tavolino in metallo verniciato - piano in lamiera zincata  
coffee table - top in galvanized sheet metal

100% produzione italiana / 100% made in italy

disponibili su richiesta altre finiture ral / other ral finishes on request

su richiesta i basamenti sono disponibili in qualsiasi misura / on request, the bases are available in any size.

applicazione piano hpl su richiesta / application ton hpl on request

disponibili su richiesta trattamenti di cataforesi e zincatura per zone marine  
cataphoresis and galvanizing treatments for marine areas are available on request

prodotto product	codice code	misura basamento base size	misura colonna column size	finitura finishing	altezza height	peso weight	prezzo price
cuba-libre	cuba-libre	mm	mm	ral	mm	kg	€
	cuba-libre	Ø 440	30x3	black 9017 white 9016 antracite 7021 aluminium 9006 grey beige 7032	400	7	213
	cuba-libre	Ø 570	30x3	black 9017 white 9016 antracite 7021 aluminium 9006 grey beige 7032	510	10	240
	cuba-libre	Ø 570	30x3	black 9017 white 9016 antracite 7021 aluminium 9006 grey beige 7032	750	12	266

# mars

tavolino - small table

tavolino in metallo verniciato - piano in lamiera zincata / coffee table - top in galvanized sheet metal

100% produzione italiana / 100% made in italy

disponibili su richiesta altre finiture ral / other ral finishes on request

prodotto product	codice code	misura basamento base size	misura colonna column size	finitura finishing	altezza height	peso weight	prezzo price
mars	mars	mm	mm	ral	mm	kg	€
	mars small	450x550	0,4	black 9017 white 9016 antracite 7021 aluminium 9006 grey beige 7032	400	3	216
	mars medium	550x700	0,4	black 9017 white 9016 antracite 7021 aluminium 9006 grey beige 7032	370	5	288
	mars big	700x1000	0,4	black 9017 white 9016 antracite 7021 aluminium 9006 grey beige 7032	340	7	422

# key

tavolino - small table

tavolino in metallo verniciato - piano in lamiera zincata / coffee table - top in galvanized sheet metal

100% produzione italiana / 100% made in italy

disponibili su richiesta altre finiture ral / other ral finishes on request

prodotto product	codice code	misura basamento base size	misura colonna column size	finitura finishing	altezza height	peso weight	prezzo price
key	key	mm	mm	ral	mm	kg	€
	key small	Ø 410	0,4	black 9017 white 9016 antracite 7021 aluminium 9006 grey beige 7032	460	3	420
	key medium	Ø 710	0,4	black 9017 white 9016 antracite 7021 aluminium 9006 grey beige 7032	380	5	600

# santiago

tavolino - small table

tavolino in alluminio verniciato - piano in lamiera zincata / aluminium coffee table - top in galvanized sheet metal

100% produzione italiana / 100% made in italy

su richiesta i basamenti sono disponibili in qualsiasi misura / on request, the bases are available in any size

disponibili su richiesta altre finiture ral / other ral finishes on request

applicazione piano hpl su richiesta / application ton hpl on request

disponibili su richiesta trattamenti di cataforesi e zincatura per zone marine  
cataphoresis and galvanizing treatments for marine areas are available on request

prodotto product	codice code	misura basamento base size	misura colonna column size	finitura finishing	altezza height	peso weight	prezzo price
santiago	ft santiago	mm	mm	ral	mm	kg	€
	ft santiago	36x36	30x30	black 9017 white 9016 antracite 7021 aluminium 9006 grey beige 7032	400	5	240



# hpl 410

misura pannello / maximum panel size - mm 4200x1610

100% produzione italiana / 100% made in italy

inserimento bussola o foratura filettata / insert bush or threaded hole

imballo su pallet / packaging on pallets

se non vengono rispettati i multipli, contattare l'ufficio commerciale / if the multiples are not respected, contact the sales office

codice code	finitura finishing	misura size mm	bordo edge	spessore thickness mm	inclinazione bordo edge tilt	volume volume m3	peso weight kg	multipli pz multiples pcs	€
410	bianco - white	600x600	interno nero black edge	10	dritto-straight ahead o 25°	0,036	5	12	141
410	bianco - white	700x700	interno nero black edge	10	dritto-straight ahead o 25°	0,49	7	10	163
410	bianco - white	800x800	interno nero black edge	10	dritto-straight ahead o 25°	0,64	9	10	154
410	bianco - white	900x900	interno nero black edge	10	dritto-straight ahead o 25°	0,81	11	4	311
410	bianco - white	1200x800	interno nero black edge	10	dritto-straight ahead o 25°	0,96	14	6	264
410	bianco - white	1600x800	interno nero black edge	10	dritto-straight ahead o 25°	1,28	15	5	306
410	bianco - white	1800x900	interno nero black edge	10	dritto-straight ahead o 25°	1,62	23	2	577
410	bianco - white	2200x800	interno nero black edge	10	dritto-straight ahead o 25°	1,76	25	2	415
410	bianco - white	2500x1000	interno nero black edge	10	dritto-straight ahead o 25°	2,51	36	1	733

codice code	finitura finishing	misura size mm	bordo edge	spessore thickness mm	inclinazione bordo edge tilt	volume volume m3	peso weight kg	multipli pz multiples pcs	€
410	bianco - white	Ø 500	interno nero black edge	10	dritto-straight ahead o 25°	0,25	3	20	111
410	bianco - white	Ø 600	interno nero black edge	10	dritto-straight ahead o 25°	0,36	4	17	111
410	bianco - white	Ø 700	interno nero black edge	10	dritto-straight ahead o 25°	0,49	5	12	141
410	bianco - white	Ø 800	interno nero black edge	10	dritto-straight ahead o 25°	0,64	7	9	171
410	bianco - white	Ø 900	interno nero black edge	10	dritto-straight ahead o 25°	0,81	9	6	231
410	bianco - white	Ø 1200	interno nero black edge	10	dritto-straight ahead o 25°	1,45	16	3	400
410	bianco - white	Ø 1400	interno nero black edge	10	dritto-straight ahead o 25°	1,96	22	2	445
410	bianco - white	Ø 1600	interno nero black edge	10	dritto-straight ahead o 25°	2,56	29	2	494

# hpl 421

misura pannello / maximum panel size - mm 4200x1610

100% produzione italiana / 100% made in italy

inserimento bussola o foratura filettata / insert bush or threaded hole

imballo su pallet / packaging on pallets

se non vengono rispettati i multipli, contattare l'ufficio commerciale / if the multiples are not respected, contact the sales office

codice code	finitura finishing	misura size mm	bordo edge	spessore thickness mm	inclinazione bordo edge tilt	volume volume m3	peso weight kg	multipli pz multiples pcs	€
421	climb nero - black	600x600	interno nero black edge	10	dritto-straight ahead o 25°	0,036	5	12	145
421	climb nero - black	700x700	interno nero black edge	10	dritto-straight ahead o 25°	0,49	7	10	170
421	climb nero - black	800x800	interno nero black edge	10	dritto-straight ahead o 25°	0,64	9	10	177
421	climb nero - black	900x900	interno nero black edge	10	dritto-straight ahead o 25°	0,81	11	4	322
421	climb nero - black	1200x800	interno nero black edge	10	dritto-straight ahead o 25°	0,96	14	6	266
421	climb nero - black	1600x800	interno nero black edge	10	dritto-straight ahead o 25°	1,28	15	5	320
421	climb nero - black	1800x900	interno nero black edge	10	dritto-straight ahead o 25°	1,62	23	2	603
421	climb nero - black	2200x800	interno nero black edge	10	dritto-straight ahead o 25°	1,76	25	2	403
421	climb nero - black	2500x1000	interno nero black edge	10	dritto-straight ahead o 25°	2,51	36	1	766

codice code	finitura finishing	misura size mm	bordo edge	spessore thickness mm	inclinazione bordo edge tilt	volume volume m3	peso weight kg	multipli pz multiples pcs	€
421	climb nero - black	Ø 500	interno nero black edge	10	dritto-straight ahead o 25°	0,25	3	20	115
421	climb nero - black	Ø 600	interno nero black edge	10	dritto-straight ahead o 25°	0,36	4	17	115
421	climb nero - black	Ø 700	interno nero black edge	10	dritto-straight ahead o 25°	0,49	5	12	145
421	climb nero - black	Ø 800	interno nero black edge	10	dritto-straight ahead o 25°	0,64	7	9	193
421	climb nero - black	Ø 900	interno nero black edge	10	dritto-straight ahead o 25°	0,81	9	6	237
421	climb nero - black	Ø 1200	interno nero black edge	10	dritto-straight ahead o 25°	1,45	16	3	416
421	climb nero - black	Ø 1400	interno nero black edge	10	dritto-straight ahead o 25°	1,96	22	2	464
421	climb nero - black	Ø 1600	interno nero black edge	10	dritto-straight ahead o 25°	2,56	29	2	514

# hpl 545

misura pannello / maximum panel size - mm 4200x1610

100% produzione italiana / 100% made in italy

inserimento bussola o foratura filettata / insert bush or threaded hole

imballo su pallet / packaging on pallets

se non vengono rispettati i multipli, contattare l'ufficio commerciale / if the multiples are not respected, contact the sales office

codice code	finitura finishing	misura size mm	bordo edge	spessore thickness mm	inclinazione bordo edge tilt	volume volume m3	peso weight kg	multipli pz multiples pcs	€
545	climb vulcano	600x600	interno nero black edge	10	dritto-straight ahead o 25°	0,036	5	12	144
545	climb vulcano	700x700	interno nero black edge	10	dritto-straight ahead o 25°	0,49	7	10	170
545	climb vulcano	800x800	interno nero black edge	10	dritto-straight ahead o 25°	0,64	9	10	177
545	climb vulcano	900x900	interno nero black edge	10	dritto-straight ahead o 25°	0,81	11	4	322
545	climb vulcano	1200x800	interno nero black edge	10	dritto-straight ahead o 25°	0,96	14	6	266
545	climb vulcano	1600x800	interno nero black edge	10	dritto-straight ahead o 25°	1,28	15	5	320
545	climb vulcano	1800x900	interno nero black edge	10	dritto-straight ahead o 25°	1,62	23	2	603
545	climb vulcano	2200x800	interno nero black edge	10	dritto-straight ahead o 25°	1,76	25	2	430
545	climb vulcano	2500x1000	interno nero black edge	10	dritto-straight ahead o 25°	2,51	36	1	767

codice code	finitura finishing	misura size mm	bordo edge	spessore thickness mm	inclinazione bordo edge tilt	volume volume m3	peso weight kg	multipli pz multiples pcs	€
545	climb vulcano	Ø 500	interno nero black edge	10	dritto-straight ahead o 25°	0,25	3	20	115
545	climb vulcano	Ø 600	interno nero black edge	10	dritto-straight ahead o 25°	0,36	4	17	115
545	climb vulcano	Ø 700	interno nero black edge	10	dritto-straight ahead o 25°	0,49	5	12	145
545	climb vulcano	Ø 800	interno nero black edge	10	dritto-straight ahead o 25°	0,64	7	9	193
545	climb vulcano	Ø 900	interno nero black edge	10	dritto-straight ahead o 25°	0,81	9	6	237
545	climb vulcano	Ø 1200	interno nero black edge	10	dritto-straight ahead o 25°	1,45	16	3	416
545	climb vulcano	Ø 1400	interno nero black edge	10	dritto-straight ahead o 25°	1,96	22	2	464
545	climb vulcano	Ø 1600	interno nero black edge	10	dritto-straight ahead o 25°	2,56	29	2	515

# hpl 2811

misura pannello / maximum panel size - mm 4200x1300

100% produzione italiana / 100% made in italy

inserimento bussola o foratura filettata / insert bush or threaded hole

imballo su pallet / packaging on pallets

se non vengono rispettati i multipli, contattare l'ufficio commerciale / if the multiples are not respected, contact the sales office

codice code	finitura finishing	misura size mm	bordo edge	spessore thickness mm	inclinazione bordo edge tilt	volume volume m3	peso weight kg	multipli pz multiples pcs	€
2811	climb mongolia	600x600	interno marrone - brown edge	10	dritto-straight ahead o 25°	0,036	5	12	127
2811	climb mongolia	700x700	interno marrone - brown edge	10	dritto-straight ahead o 25°	0,49	7	5	218
2811	climb mongolia	800x800	interno marrone - brown edge	10	dritto-straight ahead o 25°	0,64	9	5	227
2811	climb mongolia	900x900	interno marrone - brown edge	10	dritto-straight ahead o 25°	0,81	11	4	273
2811	climb mongolia	1200x800	interno marrone - brown edge	10	dritto-straight ahead o 25°	0,96	14	3	353
2811	climb mongolia	1600x800	interno marrone - brown edge	10	dritto-straight ahead o 25°	1,28	15	2	412
2811	climb mongolia	1800x900	interno marrone - brown edge	10	dritto-straight ahead o 25°	1,62	23	2	504
2811	climb mongolia	2200x800	interno marrone - brown edge	10	dritto-straight ahead o 25°	1,76	25	1	575
2811	climb mongolia	2500x1000	interno marrone - brown edge	10	dritto-straight ahead o 25°	2,51	36	1	642

codice code	finitura finishing	misura size mm	bordo edge	spessore thickness mm	inclinazione bordo edge tilt	volume volume m3	peso weight kg	multipli pz multiples pcs	€
2811	climb mongolia	Ø 500	interno marrone - brown edge	10	dritto-straight ahead o 25°	0,25	3	20	126
2811	climb mongolia	Ø 600	interno marrone - brown edge	10	dritto-straight ahead o 25°	0,36	4	13	126
2811	climb mongolia	Ø 700	interno marrone - brown edge	10	dritto-straight ahead o 25°	0,49	5	9	148
2811	climb mongolia	Ø 800	interno marrone - brown edge	10	dritto-straight ahead o 25°	0,64	7	6	196
2811	climb mongolia	Ø 900	interno marrone - brown edge	10	dritto-straight ahead o 25°	0,81	9	5	231
2811	climb mongolia	Ø 1200	interno marrone - brown edge	10	dritto-straight ahead o 25°	1,45	16	3	336

# hpl 6084

misura pannello / maximum panel size - mm 4200x1300

100% produzione italiana / 100% made in italy

inserimento bussola o foratura filettata / insert bush or threaded hole

imballo su pallet / packaging on pallets

se non vengono rispettati i multipli, contattare l'ufficio commerciale / if the multiples are not respected, contact the sales office

codice code	finitura finishing	misura size mm	bordo edge	spessore thickness mm	inclinazione bordo edge tilt	volume volume m3	peso weight kg	multipli pz multiples pcs	€
6084	plus jazz	600x600	interno nero black edge	10	dritto-straight ahead o 25°	0,036	5	12	206
6084	plus jazz	700x700	interno nero black edge	10	dritto-straight ahead o 25°	0,49	7	5	397
6084	plus jazz	800x800	interno nero black edge	10	dritto-straight ahead o 25°	0,64	9	5	408
6084	plus jazz	900x900	interno nero black edge	10	dritto-straight ahead o 25°	0,81	11	4	500
6084	plus jazz	1200x800	interno nero black edge	10	dritto-straight ahead o 25°	0,96	14	3	647
6084	plus jazz	1600x800	interno nero black edge	10	dritto-straight ahead o 25°	1,28	15	2	765
6084	plus jazz	1800x900	interno nero black edge	10	dritto-straight ahead o 25°	1,62	23	2	951
6084	plus jazz	2200x800	interno nero black edge	10	dritto-straight ahead o 25°	1,76	25	1	1083
6084	plus jazz	2500x1000	interno nero black edge	10	dritto-straight ahead o 25°	2,51	36	1	1217

codice code	finitura finishing	misura size mm	bordo edge	spessore thickness mm	inclinazione bordo edge tilt	volume volume m3	peso weight kg	multipli pz multiples pcs	€
6084	plus jazz	Ø 500	interno nero black edge	10	dritto-straight ahead o 25°	0,25	3	20	186
6084	plus jazz	Ø 600	interno nero black edge	10	dritto-straight ahead o 25°	0,36	4	13	186
6084	plus jazz	Ø 700	interno nero black edge	10	dritto-straight ahead o 25°	0,49	5	9	244
6084	plus jazz	Ø 800	interno nero black edge	10	dritto-straight ahead o 25°	0,64	7	6	343
6084	plus jazz	Ø 900	interno nero black edge	10	dritto-straight ahead o 25°	0,81	9	5	408
6084	plus jazz	Ø 1200	interno nero black edge	10	dritto-straight ahead o 25°	1,45	16	3	657

# hpl 2810

misura pannello / maximum panel size - mm 4200x1300

100% produzione italiana / 100% made in italy

inserimento bussola o foratura filettata / insert bush or threaded hole

imballo su pallet / packaging on pallets

se non vengono rispettati i multipli, contattare l'ufficio commerciale / if the multiples are not respected, contact the sales office

codice code	finitura finishing	misura size mm	bordo edge	spessore thickness mm	inclinazione bordo edge tilt	volume volume m3	peso weight kg	multipli pz multiples pcs	€
2810	climb cemento	600x600	interno nero black edge	10	dritto-straight ahead o 25°	0,036	5	12	206
2810	climb cemento	700x700	interno nero black edge	10	dritto-straight ahead o 25°	0,49	7	5	224
2810	climb cemento	800x800	interno nero black edge	10	dritto-straight ahead o 25°	0,64	9	5	233
2810	climb cemento	900x900	interno nero black edge	10	dritto-straight ahead o 25°	0,81	11	4	282
2810	climb cemento	1200x800	interno nero black edge	10	dritto-straight ahead o 25°	0,96	14	3	360
2810	climb cemento	1600x800	interno nero black edge	10	dritto-straight ahead o 25°	1,28	15	2	422
2810	climb cemento	1800x900	interno nero black edge	10	dritto-straight ahead o 25°	1,62	23	2	520
2810	climb cemento	2200x800	interno nero black edge	10	dritto-straight ahead o 25°	1,76	25	1	593
2810	climb cemento	2500x1000	interno nero black edge	10	dritto-straight ahead o 25°	2,51	36	1	660

codice code	finitura finishing	misura size mm	bordo edge	spessore thickness mm	inclinazione bordo edge tilt	volume volume m3	peso weight kg	multipli pz multiples pcs	€
2810	climb cemento	Ø 500	interno nero black edge	10	dritto-straight ahead o 25°	0,25	3	20	119
2810	climb cemento	Ø 600	interno nero black edge	10	dritto-straight ahead o 25°	0,36	4	13	119
2810	climb cemento	Ø 700	interno nero black edge	10	dritto-straight ahead o 25°	0,49	5	9	153
2810	climb cemento	Ø 800	interno nero black edge	10	dritto-straight ahead o 25°	0,64	7	6	180
2810	climb cemento	Ø 900	interno nero black edge	10	dritto-straight ahead o 25°	0,81	9	5	233
2810	climb cemento	Ø 1200	interno nero black edge	10	dritto-straight ahead o 25°	1,45	16	3	361

# hpl 6076

misura pannello / maximum panel size - mm 4200x1300

100% produzione italiana / 100% made in italy

inserimento bussola o foratura filettata / insert bush or threaded hole

imballo su pallet / packaging on pallets

se non vengono rispettati i multipli, contattare l'ufficio commerciale / if the multiples are not respected, contact the sales office

codice code	finitura finishing	misura size mm	bordo edge	spessore thickness mm	inclinazione bordo edge tilt	volume volume m3	peso weight kg	multipli pz multiples pcs	€
6076	plamky impero	600x600	interno nero black edge	10	dritto-straight ahead o 25°	0,036	5	12	155
6076	plamky impero	700x700	interno nero black edge	10	dritto-straight ahead o 25°	0,49	7	5	284
6076	plamky impero	800x800	interno nero black edge	10	dritto-straight ahead o 25°	0,64	9	5	294
6076	plamky impero	900x900	interno nero black edge	10	dritto-straight ahead o 25°	0,81	11	4	357
6076	plamky impero	1200x800	interno nero black edge	10	dritto-straight ahead o 25°	0,96	14	3	460
6076	plamky impero	1600x800	interno nero black edge	10	dritto-straight ahead o 25°	1,28	15	2	543
6076	plamky impero	1800x900	interno nero black edge	10	dritto-straight ahead o 25°	1,62	23	2	888
6076	plamky impero	2200x800	interno nero black edge	10	dritto-straight ahead o 25°	1,76	25	1	761
6076	plamky impero	2500x1000	interno nero black edge	10	dritto-straight ahead o 25°	2,51	36	1	854

codice code	finitura finishing	misura size mm	bordo edge	spessore thickness mm	inclinazione bordo edge tilt	volume volume m3	peso weight kg	multipli pz multiples pcs	€
6076	plamky impero	Ø 500	interno nero black edge	10	dritto-straight ahead o 25°	0,25	3	20	141
6076	plamky impero	Ø 600	interno nero black edge	10	dritto-straight ahead o 25°	0,36	4	13	141
6076	plamky impero	Ø 700	interno nero black edge	10	dritto-straight ahead o 25°	0,49	5	9	185
6076	plamky impero	Ø 800	interno nero black edge	10	dritto-straight ahead o 25°	0,64	7	6	252
6076	plamky impero	Ø 900	interno nero black edge	10	dritto-straight ahead o 25°	0,81	9	5	295
6076	plamky impero	Ø 1200	interno nero black edge	10	dritto-straight ahead o 25°	1,45	16	3	464

# hpl 868

misura pannello / maximum panel size - mm 4200x1300

100% produzione italiana / 100% made in italy

inserimento bussola o foratura filettata / insert bush or threaded hole

imballo su pallet / packaging on pallets

se non vengono rispettati i multipli, contattare l'ufficio commerciale / if the multiples are not respected, contact the sales office

codice code	finitura finishing	misura size mm	bordo edge	spessore thickness mm	inclinazione bordo edge tilt	volume volume m3	peso weight kg	multipli pz multiples pcs	€
868	climb grigio/grey	600x600	interno grigio grey edge	10	dritto-straight ahead o 25°	0,036	5	12	193
868	climb grigio/grey	700x700	interno grigio grey edge	10	dritto-straight ahead o 25°	0,49	7	5	363
868	climb grigio/grey	800x800	interno grigio grey edge	10	dritto-straight ahead o 25°	0,64	9	5	376
868	climb grigio/grey	900x900	interno grigio grey edge	10	dritto-straight ahead o 25°	0,81	11	4	460
868	climb grigio/grey	1200x800	interno grigio grey edge	10	dritto-straight ahead o 25°	0,96	14	3	595
868	climb grigio/grey	1600x800	interno grigio grey edge	10	dritto-straight ahead o 25°	1,28	15	2	705
868	climb grigio/grey	1800x900	interno grigio grey edge	10	dritto-straight ahead o 25°	1,62	23	2	874
868	climb grigio/grey	2200x800	interno grigio grey edge	10	dritto-straight ahead o 25°	1,76	25	1	995
868	climb grigio/grey	2500x1000	interno grigio grey edge	10	dritto-straight ahead o 25°	2,51	36	1	1117

codice code	finitura finishing	misura size mm	bordo edge	spessore thickness mm	inclinazione bordo edge tilt	volume volume m3	peso weight kg	multipli pz multiples pcs	€
868	climb grigio/grey	Ø 500	interno grigio grey edge	10	dritto-straight ahead o 25°	0,25	3	20	174
868	climb grigio/grey	Ø 600	interno grigio grey edge	10	dritto-straight ahead o 25°	0,36	4	13	174
868	climb grigio/grey	Ø 700	interno grigio grey edge	10	dritto-straight ahead o 25°	0,49	5	9	233
868	climb grigio/grey	Ø 800	interno grigio grey edge	10	dritto-straight ahead o 25°	0,64	7	6	318
868	climb grigio/grey	Ø 900	interno grigio grey edge	10	dritto-straight ahead o 25°	0,81	9	5	377
868	climb grigio/grey	Ø 1200	interno grigio grey edge	10	dritto-straight ahead o 25°	1,45	16	3	604

# hpl 5555

misura pannello / maximum panel size - mm 4200x1300

100% produzione italiana / 100% made in italy

inserimento bussola o foratura filettata / insert bush or threaded hole

imballo su pallet / packaging on pallets

se non vengono rispettati i multipli, contattare l'ufficio commerciale / if the multiples are not respected, contact the sales office

codice code	finitura finishing	misura size mm	bordo edge	spessore thickness mm	inclinazione bordo edge tilt	volume volume m3	peso weight kg	multipli pz multiples pcs	€
5555	flamky botticino	600x600	interno nero black edge	10	dritto-straight ahead o 25°	0,036	5	12	222
5555	flamky botticino	700x700	interno nero black edge	10	dritto-straight ahead o 25°	0,49	7	5	429
5555	flamky botticino	800x800	interno nero black edge	10	dritto-straight ahead o 25°	0,64	9	5	443
5555	flamky botticino	900x900	interno nero black edge	10	dritto-straight ahead o 25°	0,81	11	4	544
5555	flamky botticino	1200x800	interno nero black edge	10	dritto-straight ahead o 25°	0,96	14	3	826
5555	flamky botticino	1600x800	interno nero black edge	10	dritto-straight ahead o 25°	1,28	15	2	835
5555	flamky botticino	1800x900	interno nero black edge	10	dritto-straight ahead o 25°	1,62	23	2	1045
5555	flamky botticino	2200x800	interno nero black edge	10	dritto-straight ahead o 25°	1,76	25	1	1185
5555	flamky botticino	2500x1000	interno nero black edge	10	dritto-straight ahead o 25°	2,51	36	1	2423

codice code	finitura finishing	misura size mm	bordo edge	spessore thickness mm	inclinazione bordo edge tilt	volume volume m3	peso weight kg	multipli pz multiples pcs	€
5555	flamky botticino	Ø 500	interno nero black edge	10	dritto-straight ahead o 25°	0,25	3	20	200
5555	flamky botticino	Ø 600	interno nero black edge	10	dritto-straight ahead o 25°	0,36	4	13	200
5555	flamky botticino	Ø 700	interno nero black edge	10	dritto-straight ahead o 25°	0,49	5	9	271
5555	flamky botticino	Ø 800	interno nero black edge	10	dritto-straight ahead o 25°	0,64	7	6	375
5555	flamky botticino	Ø 900	interno nero black edge	10	dritto-straight ahead o 25°	0,81	9	5	543
5555	flamky botticino	Ø 1200	interno nero black edge	10	dritto-straight ahead o 25°	1,45	16	3	715

# hpl 5547

misura pannello / maximum panel size - mm 4200x1300

100% produzione italiana / 100% made in italy

inserimento bussola o foratura filettata / insert bush or threaded hole

imballo su pallet / packaging on pallets

se non vengono rispettati i multipli, contattare l'ufficio commerciale / if the multiples are not respected, contact the sales office

codice code	finitura finishing	misura size mm	bordo edge	spessore thickness mm	inclinazione bordo edge tilt	volume volume m3	peso weight kg	multipli pz multiples pcs	€
5547	flamky statuario	600x600	interno nero black edge	10	dritto-straight ahead o 25°	0,036	5	12	222
5547	flamky statuario	700x700	interno nero black edge	10	dritto-straight ahead o 25°	0,49	7	5	428
5547	flamky statuario	800x800	interno nero black edge	10	dritto-straight ahead o 25°	0,64	9	5	443
5547	flamky statuario	900x900	interno nero black edge	10	dritto-straight ahead o 25°	0,81	11	4	531
5547	flamky statuario	1200x800	interno nero black edge	10	dritto-straight ahead o 25°	0,96	14	3	688
5547	flamky statuario	1600x800	interno nero black edge	10	dritto-straight ahead o 25°	1,28	15	2	837
5547	flamky statuario	1800x900	interno nero black edge	10	dritto-straight ahead o 25°	1,62	23	2	1044
5547	flamky statuario	2200x800	interno nero black edge	10	dritto-straight ahead o 25°	1,76	25	1	1186
5547	flamky statuario	2500x1000	interno nero black edge	10	dritto-straight ahead o 25°	2,51	36	1	2400

codice code	finitura finishing	misura size mm	bordo edge	spessore thickness mm	inclinazione bordo edge tilt	volume volume m3	peso weight kg	multipli pz multiples pcs	€
5547	flamky statuario	Ø 500	interno nero black edge	10	dritto-straight ahead o 25°	0,25	3	20	200
5547	flamky statuario	Ø 600	interno nero black edge	10	dritto-straight ahead o 25°	0,36	4	13	200
5547	flamky statuario	Ø 700	interno nero black edge	10	dritto-straight ahead o 25°	0,49	5	9	271
5547	flamky statuario	Ø 800	interno nero black edge	10	dritto-straight ahead o 25°	0,64	7	6	376
5547	flamky statuario	Ø 900	interno nero black edge	10	dritto-straight ahead o 25°	0,81	9	5	543
5547	flamky statuario	Ø 1200	interno nero black edge	10	dritto-straight ahead o 25°	1,45	16	3	715



# hpl 669

misura pannello / maximum panel size - mm 4200x1300

100% produzione italiana / 100% made in italy

inserimento bussola o foratura filettata / insert bush or threaded hole

imballo su pallet / packaging on pallets

se non vengono rispettati i multipli, contattare l'ufficio commerciale / if the multiples are not respected, contact the sales office

codice code	finitura finishing	misura size mm	bordo edge	spessore thickness mm	inclinazione bordo edge tilt	volume volume m3	peso weight kg	multipli pz multiples pcs	€
669	new wood	600x600	interno nero black edge	10	dritto-straight ahead o 25°	0,036	5	12	155
669	new wood	700x700	interno nero black edge	10	dritto-straight ahead o 25°	0,49	7	5	285
669	new wood	800x800	interno nero black edge	10	dritto-straight ahead o 25°	0,64	9	5	295
669	new wood	900x900	interno nero black edge	10	dritto-straight ahead o 25°	0,81	11	4	360
669	new wood	1200x800	interno nero black edge	10	dritto-straight ahead o 25°	0,96	14	3	460
669	new wood	1600x800	interno nero black edge	10	dritto-straight ahead o 25°	1,28	15	2	545
669	new wood	1800x900	interno nero black edge	10	dritto-straight ahead o 25°	1,62	23	2	890
669	new wood	2200x800	interno nero black edge	10	dritto-straight ahead o 25°	1,76	25	1	760
669	new wood	2500x1000	interno nero black edge	10	dritto-straight ahead o 25°	2,51	36	1	855

codice code	finitura finishing	misura size mm	bordo edge	spessore thickness mm	inclinazione bordo edge tilt	volume volume m3	peso weight kg	multipli pz multiples pcs	€
669	new wood	Ø 500	interno nero black edge	10	dritto-straight ahead o 25°	0,25	3	20	140
669	new wood	Ø 600	interno nero black edge	10	dritto-straight ahead o 25°	0,36	4	13	140
669	new wood	Ø 700	interno nero black edge	10	dritto-straight ahead o 25°	0,49	5	9	185
669	new wood	Ø 800	interno nero black edge	10	dritto-straight ahead o 25°	0,64	7	6	255
669	new wood	Ø 900	interno nero black edge	10	dritto-straight ahead o 25°	0,81	9	5	300
669	new wood	Ø 1200	interno nero black edge	10	dritto-straight ahead o 25°	1,45	16	3	465

# hpl 670

misura pannello / maximum panel size - mm 4200x1300

100% produzione italiana / 100% made in italy

inserimento bussola o foratura filettata / insert bush or threaded hole

imballo su pallet / packaging on pallets

se non vengono rispettati i multipli, contattare l'ufficio commerciale / if the multiples are not respected, contact the sales office

codice code	finitura finishing	misura size mm	bordo edge	spessore thickness mm	inclinazione bordo edge tilt	volume volume m3	peso weight kg	multipli pz multiples pcs	€
670	rovere artico	600x600	interno nero black edge	10	dritto-straight ahead o 25°	0,036	5	12	155
670	rovere artico	700x700	interno nero black edge	10	dritto-straight ahead o 25°	0,49	7	5	285
670	rovere artico	800x800	interno nero black edge	10	dritto-straight ahead o 25°	0,64	9	5	295
670	rovere artico	900x900	interno nero black edge	10	dritto-straight ahead o 25°	0,81	11	4	360
670	rovere artico	1200x800	interno nero black edge	10	dritto-straight ahead o 25°	0,96	14	3	460
670	rovere artico	1600x800	interno nero black edge	10	dritto-straight ahead o 25°	1,28	15	2	545
670	rovere artico	1800x900	interno nero black edge	10	dritto-straight ahead o 25°	1,62	23	2	890
670	rovere artico	2200x800	interno nero black edge	10	dritto-straight ahead o 25°	1,76	25	1	760
670	rovere artico	2500x1000	interno nero black edge	10	dritto-straight ahead o 25°	2,51	36	1	855

codice code	finitura finishing	misura size mm	bordo edge	spessore thickness mm	inclinazione bordo edge tilt	volume volume m3	peso weight kg	multipli pz multiples pcs	€
670	rovere artico	Ø 500	interno nero black edge	10	dritto-straight ahead o 25°	0,25	3	20	140
670	rovere artico	Ø 600	interno nero black edge	10	dritto-straight ahead o 25°	0,36	4	13	140
670	rovere artico	Ø 700	interno nero black edge	10	dritto-straight ahead o 25°	0,49	5	9	185
670	rovere artico	Ø 800	interno nero black edge	10	dritto-straight ahead o 25°	0,64	7	6	255
670	rovere artico	Ø 900	interno nero black edge	10	dritto-straight ahead o 25°	0,81	9	5	300
670	rovere artico	Ø 1200	interno nero black edge	10	dritto-straight ahead o 25°	1,45	16	3	465

# hpl 677

misura pannello / maximum panel size - mm 4200x1300

100% produzione italiana / 100% made in italy

inserimento bussola o foratura filettata / insert bush or threaded hole

imballo su pallet / packaging on pallets

se non vengono rispettati i multipli, contattare l'ufficio commerciale / if the multiples are not respected, contact the sales office

codice code	finitura finishing	misura size mm	bordo edge	spessore thickness mm	inclinazione bordo edge tilt	volume volume m3	peso weight kg	multipli pz multiples pcs	€
677	old wood	600x600	interno nero black edge	10	dritto-straight ahead o 25°	0,036	5	12	155
677	old wood	700x700	interno nero black edge	10	dritto-straight ahead o 25°	0,49	7	5	285
677	old wood	800x800	interno nero black edge	10	dritto-straight ahead o 25°	0,64	9	5	295
677	old wood	900x900	interno nero black edge	10	dritto-straight ahead o 25°	0,81	11	4	360
677	old wood	1200x800	interno nero black edge	10	dritto-straight ahead o 25°	0,96	14	3	460
677	old wood	1600x800	interno nero black edge	10	dritto-straight ahead o 25°	1,28	15	2	545
677	old wood	1800x900	interno nero black edge	10	dritto-straight ahead o 25°	1,62	23	2	890
677	old wood	2200x800	interno nero black edge	10	dritto-straight ahead o 25°	1,76	25	1	760
677	old wood	2500x1000	interno nero black edge	10	dritto-straight ahead o 25°	2,51	36	1	855

codice code	finitura finishing	misura size mm	bordo edge	spessore thickness mm	inclinazione bordo edge tilt	volume volume m3	peso weight kg	multipli pz multiples pcs	€
677	old wood	Ø 500	interno nero black edge	10	dritto-straight ahead o 25°	0,25	3	20	140
677	old wood	Ø 600	interno nero black edge	10	dritto-straight ahead o 25°	0,36	4	13	140
677	old wood	Ø 700	interno nero black edge	10	dritto-straight ahead o 25°	0,49	5	9	185
677	new wood	Ø 800	interno nero black edge	10	dritto-straight ahead o 25°	0,64	7	6	255
677	old wood	Ø 900	interno nero black edge	10	dritto-straight ahead o 25°	0,81	9	5	300
677	old wood	Ø 1200	interno nero black edge	10	dritto-straight ahead o 25°	1,45	16	3	465

# hpl 830

misura pannello / maximum panel size - mm 4200x1300

100% produzione italiana / 100% made in italy

inserimento bussola o foratura filettata / insert bush or threaded hole

imballo su pallet / packaging on pallets

se non vengono rispettati i multipli, contattare l'ufficio commerciale / if the multiples are not respected, contact the sales office

codice code	finitura finishing	misura size mm	bordo edge	spessore thickness mm	inclinazione bordo edge tilt	volume volume m3	peso weight kg	multipli pz multiples pcs	€
830	crazy horse	600x600	interno nero black edge	10	dritto-straight ahead o 25°	0,036	5	12	155
830	crazy horse	700x700	interno nero black edge	10	dritto-straight ahead o 25°	0,49	7	5	285
830	crazy horse	800x800	interno nero black edge	10	dritto-straight ahead o 25°	0,64	9	5	295
830	crazy horse	900x900	interno nero black edge	10	dritto-straight ahead o 25°	0,81	11	4	360
830	crazy horse	1200x800	interno nero black edge	10	dritto-straight ahead o 25°	0,96	14	3	460
830	crazy horse	1600x800	interno nero black edge	10	dritto-straight ahead o 25°	1,28	15	2	545
830	crazy horse	1800x900	interno nero black edge	10	dritto-straight ahead o 25°	1,62	23	2	890
830	crazy horse	2200x800	interno nero black edge	10	dritto-straight ahead o 25°	1,76	25	1	760
830	crazy horse	2500x1000	interno nero black edge	10	dritto-straight ahead o 25°	2,51	36	1	855

codice code	finitura finishing	misura size mm	bordo edge	spessore thickness mm	inclinazione bordo edge tilt	volume volume m3	peso weight kg	multipli pz multiples pcs	€
830	crazy horse	Ø 500	interno nero black edge	10	dritto-straight ahead o 25°	0,25	3	20	140
830	crazy horse	Ø 600	interno nero black edge	10	dritto-straight ahead o 25°	0,36	4	13	140
830	crazy horse	Ø 700	interno nero black edge	10	dritto-straight ahead o 25°	0,49	5	9	185
830	crazy horse	Ø 800	interno nero black edge	10	dritto-straight ahead o 25°	0,64	7	6	255
830	crazy horse	Ø 900	interno nero black edge	10	dritto-straight ahead o 25°	0,81	9	5	300
830	crazy horse	Ø 1200	interno nero black edge	10	dritto-straight ahead o 25°	1,45	16	3	465

# hpl 1824

misura pannello / maximum panel size - mm 4200x1610

100% produzione italiana / 100% made in italy

inserimento bussola o foratura filettata / insert bush or threaded hole

imballo su pallet / packaging on pallets

se non vengono rispettati i multipli, contattare l'ufficio commerciale / if the multiples are not respected, contact the sales office

codice code	finitura finishing	misura size mm	bordo edge	spessore thickness mm	inclinazione bordo edge tilt	volume volume m3	peso weight kg	multipli pz multiples pcs	€
1824	blue amorgose	600x600	interno nero black edge	10	dritto-straight ahead o 25°	0,036	5	12	193
1824	blue amorgose	700x700	interno nero black edge	10	dritto-straight ahead o 25°	0,49	7	10	193
1824	blue amorgose	800x800	interno nero black edge	10	dritto-straight ahead o 25°	0,64	9	10	200
1824	blue amorgose	900x900	interno nero black edge	10	dritto-straight ahead o 25°	0,81	11	4	362
1824	blue amorgose	1200x800	interno nero black edge	10	dritto-straight ahead o 25°	0,96	14	6	300
1824	blue amorgose	1600x800	interno nero black edge	10	dritto-straight ahead o 25°	1,28	15	5	362
1824	blue amorgose	1800x900	interno nero black edge	10	dritto-straight ahead o 25°	1,62	23	2	678
1824	blue amorgose	2200x800	interno nero black edge	10	dritto-straight ahead o 25°	1,76	25	2	765
1824	blue amorgose	2500x1000	interno nero black edge	10	dritto-straight ahead o 25°	2,51	36	1	1500

codice code	finitura finishing	misura size mm	bordo edge	spessore thickness mm	inclinazione bordo edge tilt	volume volume m3	peso weight kg	multipli pz multiples pcs	€
1824	blue amorgose	Ø 500	interno nero black edge	10	dritto-straight ahead o 25°	0,25	3	20	190
1824	blue amorgose	Ø 600	interno nero black edge	10	dritto-straight ahead o 25°	0,36	4	17	190
1824	blue amorgose	Ø 700	interno nero black edge	10	dritto-straight ahead o 25°	0,49	5	12	250
1824	blue amorgose	Ø 800	interno nero black edge	10	dritto-straight ahead o 25°	0,64	7	9	305
1824	blue amorgose	Ø 900	interno nero black edge	10	dritto-straight ahead o 25°	0,81	9	6	425
1824	blue amorgose	Ø 1200	interno nero black edge	10	dritto-straight ahead o 25°	1,45	16	3	785
1824	blue amorgose	Ø 1400	interno nero black edge	10	dritto-straight ahead o 25°	1,96	22	2	885
1824	blue amorgose	Ø 1600	interno nero black edge	10	dritto-straight ahead o 25°	2,56	29	2	985

# hpl 1850

misura pannello / maximum panel size - mm 4200x1300

100% produzione italiana / 100% made in italy

inserimento bussola o foratura filettata / insert bush or threaded hole

imballo su pallet / packaging on pallets

se non vengono rispettati i multipli, contattare l'ufficio commerciale / if the multiples are not respected, contact the sales office

codice code	finitura finishing	misura size mm	bordo edge	spessore thickness mm	inclinazione bordo edge tilt	volume volume m3	peso weight kg	multipli pz multiples pcs	€
1850	lime	600x600	interno nero black edge	10	dritto-straight ahead o 25°	0,036	5	12	155
1850	lime	700x700	interno nero black edge	10	dritto-straight ahead o 25°	0,49	7	5	285
1850	lime	800x800	interno nero black edge	10	dritto-straight ahead o 25°	0,64	9	5	295
1850	lime	900x900	interno nero black edge	10	dritto-straight ahead o 25°	0,81	11	4	360
1850	lime	1200x800	interno nero black edge	10	dritto-straight ahead o 25°	0,96	14	3	460
1850	lime	1600x800	interno nero black edge	10	dritto-straight ahead o 25°	1,28	15	2	545
1850	lime	1800x900	interno nero black edge	10	dritto-straight ahead o 25°	1,62	23	2	890
1850	lime	2200x800	interno nero black edge	10	dritto-straight ahead o 25°	1,76	25	1	760
1850	lime	2500x1000	interno nero black edge	10	dritto-straight ahead o 25°	2,51	36	1	855

codice code	finitura finishing	misura size mm	bordo edge	spessore thickness mm	inclinazione bordo edge tilt	volume volume m3	peso weight kg	multipli pz multiples pcs	€
1850	lime	Ø 500	interno nero black edge	10	dritto-straight ahead o 25°	0,25	3	20	140
1850	lime	Ø 600	interno nero black edge	10	dritto-straight ahead o 25°	0,36	4	13	140
1850	lime	Ø 700	interno nero black edge	10	dritto-straight ahead o 25°	0,49	5	9	185
1850	lime	Ø 800	interno nero black edge	10	dritto-straight ahead o 25°	0,64	7	6	255
1850	lime	Ø 900	interno nero black edge	10	dritto-straight ahead o 25°	0,81	9	5	300
1850	lime	Ø 1200	interno nero black edge	10	dritto-straight ahead o 25°	1,45	16	3	465

# hpl polaris 2903

misura pannello / maximum panel size - mm 4200x1300

100% produzione italiana / 100% made in italy

inserimento bussola o foratura filettata / insert bush or threaded hole

imballo su pallet / packaging on pallets

se non vengono rispettati i multipli, contattare l'ufficio commerciale / if the multiples are not respected, contact the sales office

codice code	finitura finishing	misura size mm	bordo edge	spessore thickness mm	inclinazione bordo edge tilt	volume volume m3	peso weight kg	multipli pz multiples pcs	€
2903	grigio perla grey perle	600x600	interno grigio grey edge	10	dritto-straight ahead o 25°	0,036	5	12	233
2903	grigio perla grey perle	700x700	interno grigio grey edge	10	dritto-straight ahead o 25°	0,49	7	5	454
2903	grigio perla grey perle	800x800	interno grigio grey edge	10	dritto-straight ahead o 25°	0,64	9	5	469
2903	grigio perla grey perle	900x900	interno grigio grey edge	10	dritto-straight ahead o 25°	0,81	11	4	576
2903	grigio perla grey perle	1200x800	interno grigio grey edge	10	dritto-straight ahead o 25°	0,96	14	3	748
2903	grigio perla grey perle	1600x800	interno grigio grey edge	10	dritto-straight ahead o 25°	1,28	15	2	887
2903	grigio perla grey perle	1800x900	interno grigio grey edge	10	dritto-straight ahead o 25°	1,62	23	2	1109
2903	grigio perla grey perle	2200x800	interno grigio grey edge	10	dritto-straight ahead o 25°	1,76	25	1	1260
2903	grigio perla grey perle	2500x1000	interno grigio grey edge	10	dritto-straight ahead o 25°	2,51	36	1	1455

codice code	finitura finishing	misura size mm	bordo edge	spessore thickness mm	inclinazione bordo edge tilt	volume volume m3	peso weight kg	multipli pz multiples pcs	€
2903	grigio perla grey perle	Ø 600	interno grigio grey edge	10	dritto-straight ahead o 25°	0,36	4	13	210
2903	grigio perla grey perle	Ø 700	interno grigio grey edge	10	dritto-straight ahead o 25°	0,49	5	9	284
2903	grigio perla grey perle	Ø 800	interno grigio grey edge	10	dritto-straight ahead o 25°	0,64	7	6	395
2903	grigio perla grey perle	Ø 900	interno grigio grey edge	10	dritto-straight ahead o 25°	0,81	9	5	377
2903	grigio perla grey perle	Ø 1200	interno grigio grey edge	10	dritto-straight ahead o 25°	1,45	16	3	755

# hpl polaris 2905

misura pannello / maximum panel size - mm 4200x1300

100% produzione italiana / 100% made in italy

inserimento bussola o foratura filettata / insert bush or threaded hole

imballo su pallet / packaging on pallets

se non vengono rispettati i multipli, contattare l'ufficio commerciale / if the multiples are not respected, contact the sales office

codice code	finitura finishing	misura size mm	bordo edge	spessore thickness mm	inclinazione bordo edge tilt	volume volume m3	peso weight kg	multipli pz multiples pcs	€
2905	gris cosmique	600x600	interno visone vison edge	10	dritto-straight ahead o 25°	0,036	5	12	233
2905	gris cosmique	700x700	interno visone vison edge	10	dritto-straight ahead o 25°	0,49	7	5	454
2905	gris cosmique	800x800	interno visone vison edge	10	dritto-straight ahead o 25°	0,64	9	5	468
2905	gris cosmique	900x900	interno visone vison edge	10	dritto-straight ahead o 25°	0,81	11	4	576
2905	gris cosmique	1200x800	interno visone vison edge	10	dritto-straight ahead o 25°	0,96	14	3	748
2905	gris cosmique	1600x800	interno visone vison edge	10	dritto-straight ahead o 25°	1,28	15	2	876
2905	gris cosmique	1800x900	interno visone vison edge	10	dritto-straight ahead o 25°	1,62	23	2	1108
2905	gris cosmique	2200x800	interno visone vison edge	10	dritto-straight ahead o 25°	1,76	25	1	1260
2905	gris cosmique	2500x1000	interno visone vison edge	10	dritto-straight ahead o 25°	2,51	36	1	1455

codice code	finitura finishing	misura size mm	bordo edge	spessore thickness mm	inclinazione bordo edge tilt	volume volume m3	peso weight kg	multipli pz multiples pcs	€
2905	gris cosmique	Ø 600	interno visone vison edge	10	dritto-straight ahead o 25°	0,36	4	13	210
2905	gris cosmique	Ø 700	interno visone vison edge	10	dritto-straight ahead o 25°	0,49	5	9	284
2905	gris cosmique	Ø 800	interno visone vison edge	10	dritto-straight ahead o 25°	0,64	7	6	395
2905	gris cosmique	Ø 900	interno visone vison edge	10	dritto-straight ahead o 25°	0,81	9	5	377
2905	gris cosmique	Ø 1200	interno visone vison edge	10	dritto-straight ahead o 25°	1,45	16	3	755

# hpl polaris 2906

misura pannello / maximum panel size - mm 4200x1300

100% produzione italiana / 100% made in italy

inserimento bussola o foratura filettata / insert bush or threaded hole

imballo su pallet / packaging on pallets

se non vengono rispettati i multipli, contattare l'ufficio commerciale / if the multiples are not respected, contact the sales office

codice code	finitura finishing	misura size mm	bordo edge	spessore thickness mm	inclinazione bordo edge tilt	volume volume m3	peso weight kg	multipli pz multiples pcs	€
2906	gris moyen	600x600	interno tortora taupè edge	10	dritto-straight ahead o 25°	0,036	5	12	245
2906	gris moyen	700x700	interno tortora taupè edge	10	dritto-straight ahead o 25°	0,49	7	5	482
2906	gris moyen	800x800	interno tortora taupè edge	10	dritto-straight ahead o 25°	0,64	9	5	496
2906	gris moyen	900x900	interno tortora taupè edge	10	dritto-straight ahead o 25°	0,81	11	4	611
2906	gris moyen	1200x800	interno tortora taupè edge	10	dritto-straight ahead o 25°	0,96	14	3	794
2906	gris moyen	1600x800	interno tortora taupè edge	10	dritto-straight ahead o 25°	1,28	15	2	943
2906	gris moyen	1800x900	interno tortora taupè edge	10	dritto-straight ahead o 25°	1,62	23	2	1180
2906	gris moyen	2200x800	interno tortora taupè edge	10	dritto-straight ahead o 25°	1,76	25	1	1338
2906	gris moyen	2500x1000	interno tortora taupè edge	10	dritto-straight ahead o 25°	2,51	36	1	1551

codice code	finitura finishing	misura size mm	bordo edge	spessore thickness mm	inclinazione bordo edge tilt	volume volume m3	peso weight kg	multipli pz multiples pcs	€
2906	gris moyen	Ø 600	interno tortora taupè edge	10	dritto-straight ahead o 25°	0,36	4	13	221
2906	gris moyen	Ø 700	interno tortora taupè edge	10	dritto-straight ahead o 25°	0,49	5	9	300
2906	gris moyen	Ø 800	interno tortora taupè edge	10	dritto-straight ahead o 25°	0,64	7	6	318
2906	gris moyen	Ø 900	interno tortora taupè edge	10	dritto-straight ahead o 25°	0,81	9	5	585
2906	gris moyen	Ø 1200	interno tortora taupè edge	10	dritto-straight ahead o 25°	1,45	16	3	804

# hpl polaris 2907

misura pannello / maximum panel size - mm 4200x1300

100% produzione italiana / 100% made in italy

inserimento bussola o foratura filettata / insert bush or threaded hole

imballo su pallet / packaging on pallets

se non vengono rispettati i multipli, contattare l'ufficio commerciale / if the multiples are not respected, contact the sales office

codice code	finitura finishing	misura size mm	bordo edge	spessore thickness mm	inclinazione bordo edge tilt	volume volume m3	peso weight kg	multipli pz multiples pcs	€
2907	foncè	600x600	interno grigio light grey edge	10	dritto-straight ahead o 25°	0,036	5	12	233
2907	foncè	700x700	interno grigio light grey edge	10	dritto-straight ahead o 25°	0,49	7	5	454
2907	foncè	800x800	interno grigio light grey edge	10	dritto-straight ahead o 25°	0,64	9	5	468
2907	foncè	900x900	interno grigio light grey edge	10	dritto-straight ahead o 25°	0,81	11	4	576
2907	foncè	1200x800	interno grigio light grey edge	10	dritto-straight ahead o 25°	0,96	14	3	748
2907	foncè	1600x800	interno grigio light grey edge	10	dritto-straight ahead o 25°	1,28	15	2	887
2907	foncè	1800x900	interno grigio light grey edge	10	dritto-straight ahead o 25°	1,62	23	2	1110
2907	foncè	2200x800	interno grigio light grey edge	10	dritto-straight ahead o 25°	1,76	25	1	1260
2907	foncè	2500x1000	interno grigio light grey edge	10	dritto-straight ahead o 25°	2,51	36	1	1455

codice code	finitura finishing	misura size mm	bordo edge	spessore thickness mm	inclinazione bordo edge tilt	volume volume m3	peso weight kg	multipli pz multiples pcs	€
2907	foncè	Ø 600	interno grigio light grey edge	10	dritto-straight ahead o 25°	0,36	4	13	210
2907	foncè	Ø 700	interno grigio light grey edge	10	dritto-straight ahead o 25°	0,49	5	9	284
2907	foncè	Ø 800	interno grigio light grey edge	10	dritto-straight ahead o 25°	0,64	7	6	395
2907	foncè	Ø 900	interno grigio light grey edge	10	dritto-straight ahead o 25°	0,81	9	5	377
2907	foncè	Ø 1200	interno grigio light grey edge	10	dritto-straight ahead o 25°	1,45	16	3	755



# hpl polaris 2908

misura pannello / maximum panel size - mm 4200x1300

100% produzione italiana / 100% made in italy

inserimento bussola o foratura filettata / insert bush or threaded hole

imballo su pallet / packaging on pallets

se non vengono rispettati i multipli, contattare l'ufficio commerciale / if the multiples are not respected, contact the sales office

codice code	finitura finishing	misura size mm	bordo edge	spessore thickness mm	inclinazione bordo edge tilt	volume volume m3	peso weight kg	multipli pz multiples pcs	€
2908	saharà	600x600	interno grigio grey edge	10	dritto-straight ahead o 25°	0,036	5	12	233
2908	saharà	700x700	interno grigio grey edge	10	dritto-straight ahead o 25°	0,49	7	5	454
2908	saharà	800x800	interno grigio grey edge	10	dritto-straight ahead o 25°	0,64	9	5	468
2908	saharà	900x900	interno grigio grey edge	10	dritto-straight ahead o 25°	0,81	11	4	576
2908	saharà	1200x800	interno grigio grey edge	10	dritto-straight ahead o 25°	0,96	14	3	748
2908	saharà	1600x800	interno grigio grey edge	10	dritto-straight ahead o 25°	1,28	15	2	887
2908	saharà	1800x900	interno grigio grey edge	10	dritto-straight ahead o 25°	1,62	23	2	1110
2908	saharà	2200x800	interno grigio grey edge	10	dritto-straight ahead o 25°	1,76	25	1	1260
2908	saharà	2500x1000	interno grigio grey edge	10	dritto-straight ahead o 25°	2,51	36	1	1455

codice code	finitura finishing	misura size mm	bordo edge	spessore thickness mm	inclinazione bordo edge tilt	volume volume m3	peso weight kg	multipli pz multiples pcs	€
2908	saharà	Ø 600	interno grigio grey edge	10	dritto-straight ahead o 25°	0,36	4	13	210
2908	saharà	Ø 700	interno grigio grey edge	10	dritto-straight ahead o 25°	0,49	5	9	284
2908	saharà	Ø 800	interno grigio grey edge	10	dritto-straight ahead o 25°	0,64	7	6	395
2908	saharà	Ø 900	interno grigio grey edge	10	dritto-straight ahead o 25°	0,81	9	5	377
2908	saharà	Ø 1200	interno grigio grey edge	10	dritto-straight ahead o 25°	1,45	16	3	755

# hpl polaris 2909

misura pannello / maximum panel size - mm 4200x1300

100% produzione italiana / 100% made in italy

inserimento bussola o foratura filettata / insert bush or threaded hole

imballo su pallet / packaging on pallets

se non vengono rispettati i multipli, contattare l'ufficio commerciale / if the multiples are not respected, contact the sales office

codice code	finitura finishing	misura size mm	bordo edge	spessore thickness mm	inclinazione bordo edge tilt	volume volume m3	peso weight kg	multipli pz multiples pcs	€
2909	gris graphite	600x600	interno grigio grey edge	10	dritto-straight ahead o 25°	0,036	5	12	245
2909	gris graphite	700x700	interno grigio grey edge	10	dritto-straight ahead o 25°	0,49	7	5	482
2909	gris graphite	800x800	interno grigio grey edge	10	dritto-straight ahead o 25°	0,64	9	5	496
2909	gris graphite	900x900	interno grigio grey edge	10	dritto-straight ahead o 25°	0,81	11	4	611
2909	gris graphite	1200x800	interno grigio grey edge	10	dritto-straight ahead o 25°	0,96	14	3	794
2909	gris graphite	1600x800	interno grigio grey edge	10	dritto-straight ahead o 25°	1,28	15	2	943
2909	gris graphite	1800x900	interno grigio grey edge	10	dritto-straight ahead o 25°	1,62	23	2	1180
2909	gris graphite	2200x800	interno grigio grey edge	10	dritto-straight ahead o 25°	1,76	25	1	1338
2909	gris graphite	2500x1000	interno grigio grey edge	10	dritto-straight ahead o 25°	2,51	36	1	1551

codice code	finitura finishing	misura size mm	bordo edge	spessore thickness mm	inclinazione bordo edge tilt	volume volume m3	peso weight kg	multipli pz multiples pcs	€
2909	gris graphite	Ø 600	interno grigio grey edge	10	dritto-straight ahead o 25°	0,36	4	13	221
2909	gris graphite	Ø 700	interno grigio grey edge	10	dritto-straight ahead o 25°	0,49	5	9	300
2909	gris graphite	Ø 800	interno grigio grey edge	10	dritto-straight ahead o 25°	0,64	7	6	418
2909	gris graphite	Ø 900	interno grigio grey edge	10	dritto-straight ahead o 25°	0,81	9	5	585
2909	gris graphite	Ø 1200	interno grigio grey edge	10	dritto-straight ahead o 25°	1,45	16	3	804



# hpl polaris 2910

misura pannello / maximum panel size - mm 4200x1300

100% produzione italiana / 100% made in italy

inserimento bussola o foratura filettata / insert bush or threaded hole

imballo su pallet / packaging on pallets

se non vengono rispettati i multipli, contattare l'ufficio commerciale / if the multiples are not respected, contact the sales office

codice code	finitura finishing	misura size mm	bordo edge	spessore thickness mm	inclinazione bordo edge tilt	volume volume m3	peso weight kg	multipli pz multiples pcs	€
2910	gris clair	600x600	interno grigio light grey edge	10	dritto-straight ahead o 25°	0,036	5	12	233
2910	gris clair	700x700	interno grigio light grey edge	10	dritto-straight ahead o 25°	0,49	7	5	455
2910	gris clair	800x800	interno grigio light grey edge	10	dritto-straight ahead o 25°	0,64	9	5	470
2910	gris clair	900x900	interno grigio light grey edge	10	dritto-straight ahead o 25°	0,81	11	4	576
2910	gris clair	1200x800	interno grigio light grey edge	10	dritto-straight ahead o 25°	0,96	14	3	748
2910	gris clair	1600x800	interno grigio light grey edge	10	dritto-straight ahead o 25°	1,28	15	2	888
2910	gris clair	1800x900	interno grigio light grey edge	10	dritto-straight ahead o 25°	1,62	23	2	1108
2910	gris clair	2200x800	interno grigio light grey edge	10	dritto-straight ahead o 25°	1,76	25	1	1260
2910	gris clair	2500x1000	interno grigio light grey edge	10	dritto-straight ahead o 25°	2,51	36	1	1455

codice code	finitura finishing	misura size mm	bordo edge	spessore thickness mm	inclinazione bordo edge tilt	volume volume m3	peso weight kg	multipli pz multiples pcs	€
2910	gris clair	Ø 600	interno grigio light grey edge	10	dritto-straight ahead o 25°	0,36	4	13	210
2910	gris clair	Ø 700	interno grigio light grey edge	10	dritto-straight ahead o 25°	0,49	5	9	285
2910	gris clair	Ø 800	interno grigio light grey edge	10	dritto-straight ahead o 25°	0,64	7	6	395
2910	gris clair	Ø 900	interno grigio light grey edge	10	dritto-straight ahead o 25°	0,81	9	5	378
2910	gris clair	Ø 1200	interno grigio light grey edge	10	dritto-straight ahead o 25°	1,45	16	3	755

# table top

piano tavolo lamiera zincata / sheet galvanized metal table top

100% produzione italiana / 100% made in italy

disponibili su richiesta altre finiture ral / other ral finishes on request

imballo su pallet / packaging on pallets

prodotto product	codice code	misura size	finitura finishing	spessore thickness	volume volume	peso weight	prezzo price
		mm	ral	mm	m3	kg	€
	L30	600x600	black 9017 white 9016 antracite 7021 aluminium 9006 grey beige 7032	30	da quantificare to be quantify	7	195
	L30	700x700	black 9017 white 9016 antracite 7021 aluminium 9006 grey beige 7032	30	da quantificare to be quantify	9	212
	L30	800x800	black 9017 white 9016 antracite 7021 aluminium 9006 grey beige 7032	30	da quantificare to be quantify	12	225
	L30	900x900	black 9017 white 9016 antracite 7021 aluminium 9006 grey beige 7032	30	da quantificare to be quantify	14	243
	L30	1000X1000	black 9017 white 9016 antracite 7021 aluminium 9006 grey beige 7032	30	da quantificare to be quantify	18	262
	L30	1200X800	black 9017 white 9016 antracite 7021 aluminium 9006 grey beige 7032	30	da quantificare to be quantify	17	260
	L30	1600X800	black 9017 white 9016 antracite 7021 aluminium 9006 grey beige 7032	30	da quantificare to be quantify	22	292
	L30	1800X800	black 9017 white 9016 antracite 7021 aluminium 9006 grey beige 7032	30	da quantificare to be quantify	25	307
	L30	2000X800	black 9017 white 9016 antracite 7021 aluminium 9006 grey beige 7032	30	da quantificare to be quantify	28	325
	L30	2500X1000	black 9017 white 9016 antracite 7021 aluminium 9006 grey beige 7032	30	da quantificare to be quantify	43	562

# table top

piano tavolo lamiera zincata / sheet galvanized metal table top

100% produzione italiana / 100% made in italy

disponibili su richiesta altre finiture ral / other ral finishes on request

imballo su pallet / packaging on pallets

prodotto product	codice code	misura size	finitura finishing	spessore thickness	volume volume	peso weight	prezzo price
		mm	ral	mm	m3	kg	€
	L30	Ø 800	black 9017 white 9016 antracite 7021 aluminium 9006 grey beige 7032	30	da quantificare to be quantify	15	312
	L30	Ø 1000	black 9017 white 9016 antracite 7021 aluminium 9006 grey beige 7032	30	da quantificare to be quantify	25	337

# table top

piano tavolo lamiera / sheet metal table top

100% produzione italiana / 100% made in italy

disponibili su richiesta altre finiture ral / other ral finishes on request

imballo su pallet / packaging on pallets

prodotto product	codice code	misura size	finitura finishing	spessore thickness	volume volume	peso weight	prezzo price
		mm	ral	mm	m3	kg	€
	L4	400X400	black 9017 white 9016 antracite 7021 aluminium 9006 grey beige 7032	4	da quantificare to be quantify	5	113
	L4	500X500	black 9017 white 9016 antracite 7021 aluminium 9006 grey beige 7032	4	da quantificare to be quantify	6	138
	L4	600X600	black 9017 white 9016 antracite 7021 aluminium 9006 grey beige 7032	4	da quantificare to be quantify	7	163

prodotto product	codice code	misura size	finitura finishing	spessore thickness	volume volume	peso weight	prezzo price
		mm	ral	mm	m3	kg	€
	L4	Ø 400	black 9017 white 9016 antracite 7021 aluminium 9006 grey beige 7032	4	da quantificare to be quantify	4	113
	L4	Ø 500	black 9017 white 9016 antracite 7021 aluminium 9006 grey beige 7032	4	da quantificare to be quantify	5	163
	L4	Ø 600	black 9017 white 9016 antracite 7021 aluminium 9006 grey beige 7032	4	da quantificare to be quantify	6	225

piano tavolo teak / table top teak

100% produzione cinese / 100% made in china

imballo su pallet / packaging on pallets

prodotto product	codice code	finitura finishing	misura size	spessore thickness	peso weight	volume volume	prezzo price
teak	teak		mm	mm	kg	m3	€
	teak	natural	600x600	20	5	0,036	235
	teak	natural	700x700	20	7	0,49	278
	teak	natural	800x800	20	8	0,64	349

prodotto product	codice code	finitura finishing	misura size	spessore thickness	peso weight	volume volume	prezzo price
teak	teak		mm	mm	kg	m3	€
	teak	natural	Ø 600	20	4	0,036	220
	teak	natural	Ø 700	20	5	0,49	247

# cuscini / cushions



cuscino acrilico idrorepellente con rivestimento sunbrella  
water repellent acrylic cushion with sunbrella cover

100% produzione italiana / 100% made in italy

minimo ordine d'acquisto 10 pz / minimum purchase order 10 pcs

prodotto product	misura size	quantità quantity	solids & stripes nattè	prezzo price
	mm			€
	35x35	10	solids & stripes 260 gr H137 cm nattè 275 gr H140 cm garanzia 5 anni 5 year warranty	115
	40x40	10	solids & stripes 260 gr H137 cm nattè 275 gr H140 cm garanzia 5 anni 5 year warranty	135
	45x45	10	solids & stripes 260 gr H137 cm nattè 275 gr H140 cm garanzia 5 anni 5 year warranty	145
	50x50	10	solids & stripes 260 gr H137 cm nattè 275 gr H140 cm garanzia 5 anni 5 year warranty	155
	60x60	10	solids & stripes 260 gr H137 cm nattè 275 gr H140 cm garanzia 5 anni 5 year warranty	165

# poggiatesta / headrest

poggiatesta con rivestimento sunbrella o tessuto nautico  
headrest with sunbrella cover or nautical fabric

100% produzione italiana / 100% made in italy

minimo ordine d'acquisto 10 pz / minimum purchase order 10 pcs

prodotto product	misura size	quantità quantity	solids & stripes nattè	prezzo price
	mm			€
	600x140x70	10	solids & stripes 260 gr H137 cm nattè 275 gr H140 cm garanzia 5 anni 5 year warranty	170

# cover

finiture standard/standard finishes

protezione in tessuto poliestere e poliuretano,  
trattamento antifungino, grammatura 220 gr/mq

fabric in polyester and polyurethane, anti fungal  
and antibacterial, 220 gr/mq

fabric

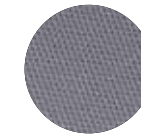

grey

prodotto product	misura size	quantità quantity	tessuto fabric	prezzo price
	mm			€
	800x800x730	2	grigio grey	166

prodotto product	misura size	quantità quantity	tessuto fabric	prezzo price
	mm			€
	1670x800x730	2	grigio grey	222

# cuscino per lettino/sunlounger cushion

cuscino acrilico idrorepellente con rivestimento sunbrella o tessuto nautico  
water repellent acrylic cushion with sunbrella cover or nautical fabric

100% produzione italiana / 100% made in italy

minimo ordine d'acquisto 10 pz / minimum purchase order 10 pcs

prodotto product	misura size	quantità quantity	solids & stripes nattè	prezzo price
	mm			€
	1950x600x50	2	solids & stripes 260 gr H137 cm nattè 275 gr H140 cm garanzia 5 anni 5 year warranty	550

il laminato print hpl (high-pressure decorative laminates) identifica il laminato decorativo ad alta pressione, un pannello costituito da strati di fibre di cellulosa impregnati con resine termoindurenti sottoposti ad un processo ad alta pressione consistente nella applicazione simultanea di calore e pressione. ciò determina la fluidificazione e la contestuale policondensazione delle resine da cui risulta un materiale omogeneo, non poroso e con la finitura superficiale richiesta.

il laminato hpl è fornito sotto forma di pannelli, disponibili in diverse dimensioni, spessori e finiture superficiali. lo spessore nominale producibile va da 0.6 a 30 mm. essenzialmente il 60% del laminato hpl è costituito da carta, mentre il restante 40% è costituito da resine termoindurenti (resina fenolica per gli strati interni e resina melaminica per lo/gli strato/strati superficiale/superficiali). alcuni laminati hpl sono costituiti da strati metallici intercalati nel cuore del pannello, mentre talune tipologie hanno lamine di metallo o impiallacciate di legno come superficie decorativa.

#### finitura climb

opaca e profonda; una matericità basica, una increspatura leggera, piacevole e non invasiva che rievoca gli elementi naturali.

print hpl is a high-pressure decorative laminate, in other words a panel consisting of layers of cellulose fibres that are impregnated with thermosetting resins and subjected to a high pressure process consisting in the simultaneous application of heat and pressure. this causes at the same time the fluidization and polycondensation of the resins, resulting in a homogeneous, non-porous material with the required surface finish. hpl is supplied as panels, available in different sizes, thicknesses and surface finishes. the nominal thickness we produce ranges from 0.6 to 30 mm. basically, 60% of hpl consists of paper, while the remaining 40% consists of thermosetting resins, typically phenolic resin for the core layers and melamine resin for the surface layer(s). some hpl laminates have metal layers reinforced core, while others have metal foils or wood veneers as the decorative surface.

#### climb finishing

deep and opaque, the texture is slightly and pleasantly ribbed in a non-invasive manner that evokes natural elements.



410  
bianco/white

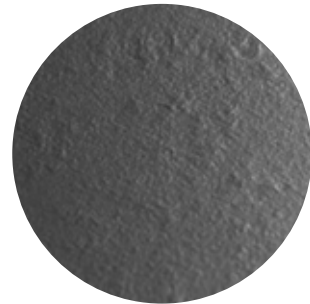

421  
climb nero/climb black

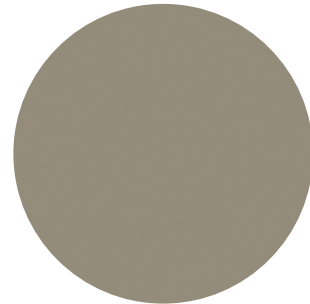

868  
climb grigio/grey

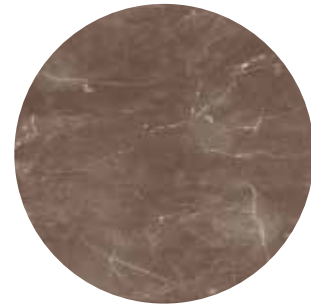

5555  
flamky botticino



596  
climb pietrogrado



545  
climb vulcano

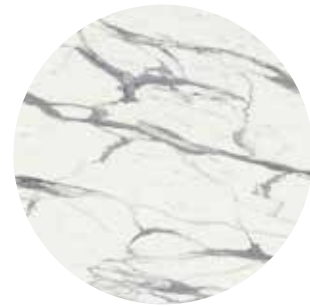

5547  
flamky statuario



2810  
climb cemento



2811  
climb mongolia

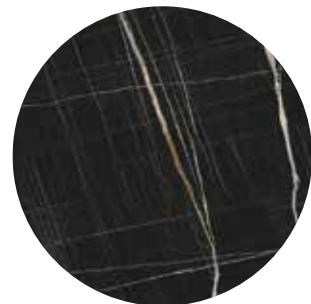

6084  
plus jazz

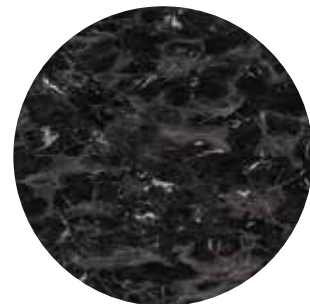

6076  
plamky impero



669  
new wood



670  
rovere artico



677  
old wood

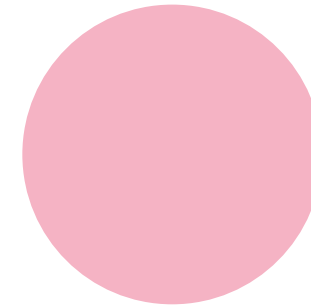

830  
crazy horse

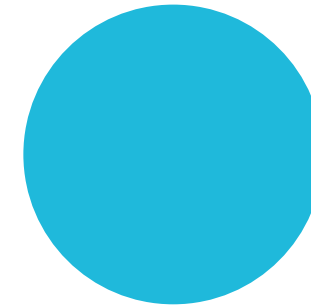

1824  
blue amorgos

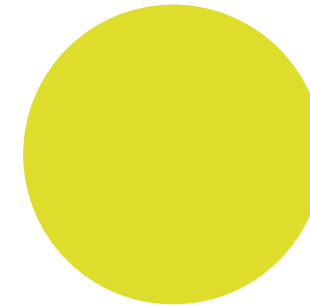

1850  
lime



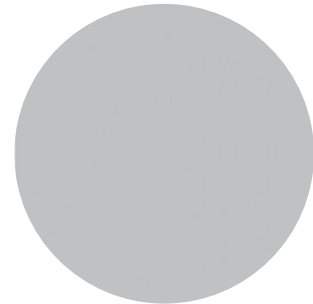

2903  
grigio perla/grey perle

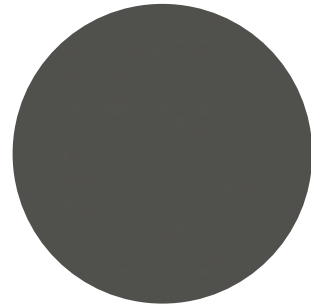

2905  
gris cosmique

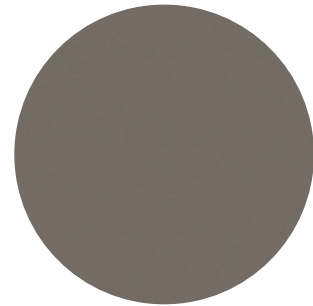

2906  
gris moyem

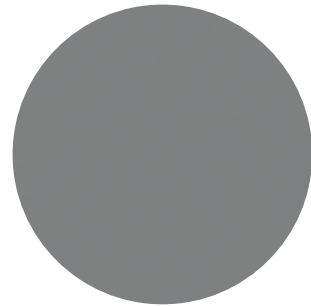

2907  
foncè

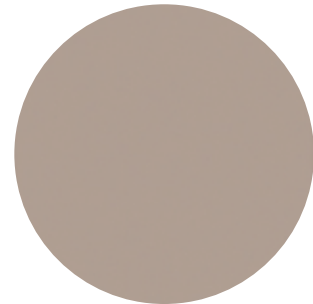

2908  
sahàrà

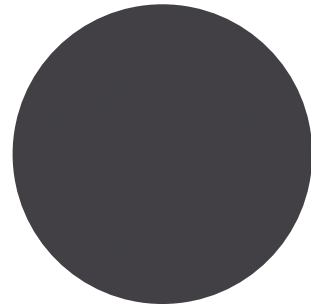

2909  
gris graphite

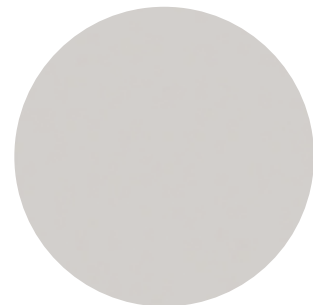

2910  
gris clair

polaris, come la luce confortante della stella polare, rappresenta un punto fermo, di arrivo, una superficie "altra", profonda e piena. il colore risulta "fondente", per un sicuro effetto innovativo e immaginifico. polaris è in testa ai prodotti di ultima generazione e costituisce un riferimento sofisticato e durevole per i progettisti più curiosi che desiderano una resa inedita.

like the comforting light of the north star, polaris, the "alternative", rich and deep surface represents a point of arrival. its mellow colour provides an undoubtedly innovative and imaginative effect. polaris leads the category of latest generation products, serving as a sophisticated and durable reference point for inquisitive designers who seek unusual results.

#### caratteristiche tecniche

caldo e vellutato al tatto - anti-impronta  
resistente ai graffi - resistente al calore  
resistente all'urto - antibatterico  
idoneo al contatto con gli alimenti

#### technical features

ultra warm and soft touch - anti-fingerprint  
scratch resistant - heat resistant  
shock resistant - anti bacterial  
suitable for applications in areas  
in contact with foodstuffs



inclinazione 25° / edge tilt 25°



bordo dritto / straight ahead



bussola / metal bush

# ropes

## all weather TEX rope



## all weather POLYOLEFIN rope



## all weather POLYESTER rope



# fabrics

## AXROMA suitable for upholstery and cushions

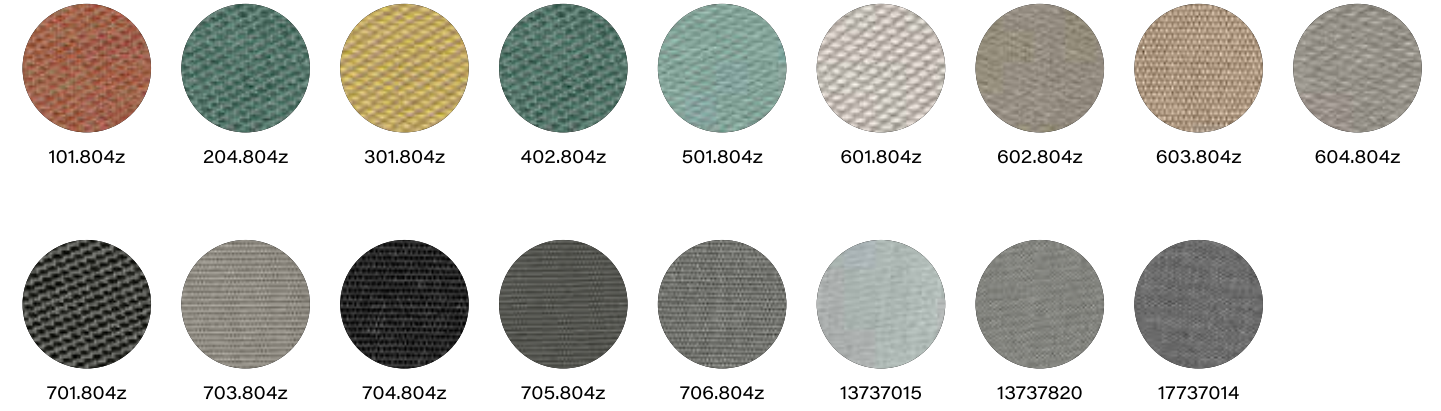

## MESH suitable for upholstery and cushions



## SUNPROOF suitable for upholstery and cushions

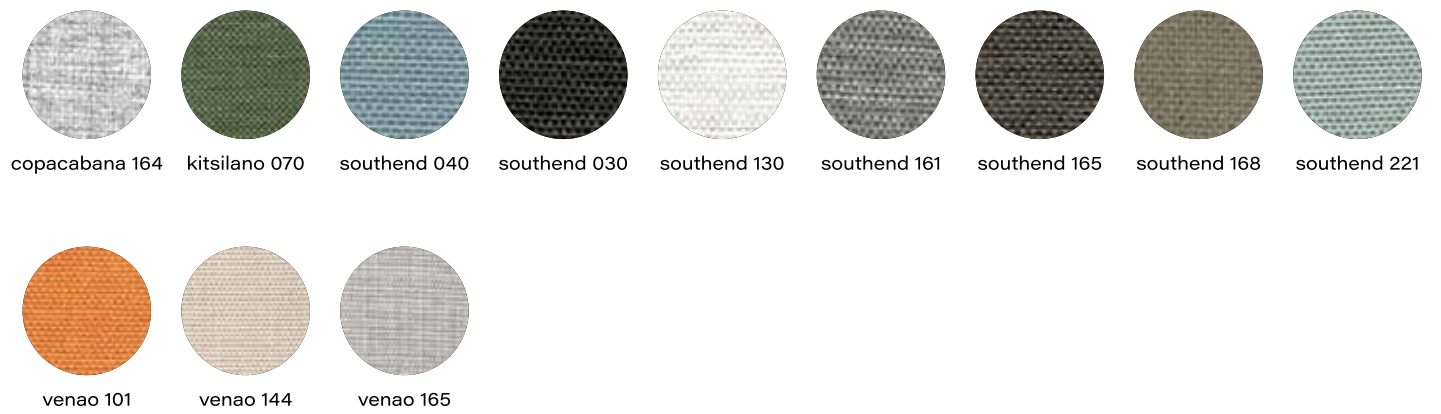

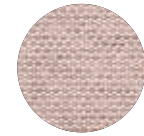

sunbrella blush 3965

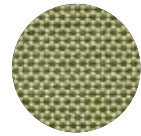

sunbrella lichen 3970

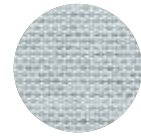

sunbrella curacao 3964



sunbrella aruba 5416

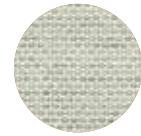

sunbrella mint 3967

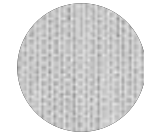

sunbrella marble 3966

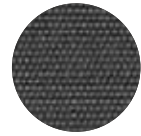

sunbrella carbon 3906

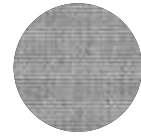

sunbrella lead chinè



sunbrella sooty 3758

## metal frame colors



black

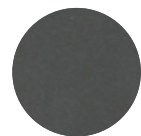

antracite



brown



dark green



olive green



light green



coral

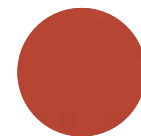

red

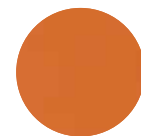

orange



pink



yellow



taupe



silver



white

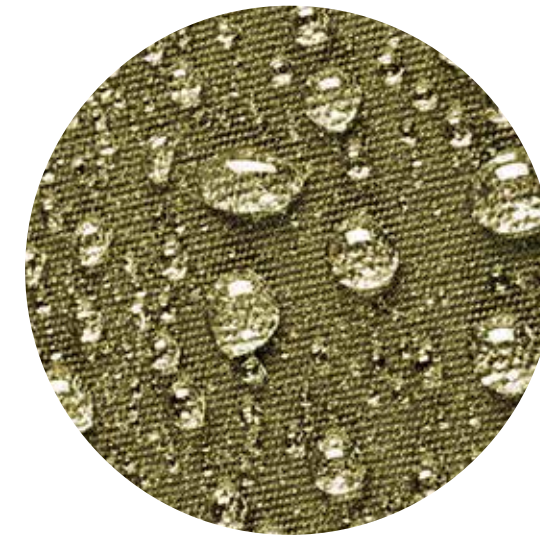

## La tecnologia idro drenante

La tecnologia idro drenante, applicata ai cuscini, si fonda sulla capacità di drenare velocemente l'acqua e di consentire un continuo ed abbondante ricircolo di aria, al fine di ottenere un'asciugatura rapida dell'imbottito e di evitare l'insorgere di muffe o il deterioramento del prodotto.

## Hydro draining technology

The hydro-draining technology applied to cushions, enable the water to drain out fast and makes for the continuous recirculation of plenty of air, so that the stuffing dries up quickly, avoiding the risk of mould formation and product deterioration.





## descrizione /description

- ombrellone robusto e pratico a palo centrale in alluminio verniciato a polveri epossidiche colore grigio antracite
- palo diam. 50 mm.
- base non compresa nel prezzo
- canaline con velcro su richiesta
- telaio in alluminio verniciato a polveri colore antracite
- viteria in acciaio inox e componenti in nylon colore nero

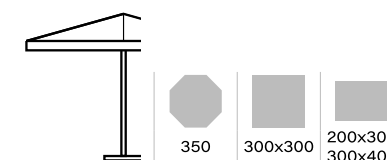

- strong and handy parasol with central pole epoxy coated color anthracite grey
- pole diam.50 mm.
- base not included in the price
- rain gutter with velcro on request
- frame in aluminium powder coated anthracite grey
- stainless steel screws and components in black nylon

		CARATTERISTICHE			ACRYL 350 GR											
					A1S	A1N	T2S - T3S	T2N - T3N	T6N - T7N T8N - T9N S1N		BC55MA4	BC80MA4	BF6565D BF6565Z	BF6666D BF6666Z	BUD8080	BTT55+BTC
	3,5	50	8	-	€ 1.030	-	€ 1.283	€ 1.283	€ 130					-		
	3,0x3,0	50	8	€ 1.070	€ 1.070	€ 1.070	-	€ 1.070	€ 130							
	2,0x3,0	50	6	€ 915	€ 915	-	-	-	€ 130					-		
	3,0x4,0	50	8	€ 1.225	€ 1.225	€ 1.585	-	€ 1.585	€ 130							

MEASURES		CHARACTERISTICS									
		KG									
3,5		15	0,10	50	-	ALU DARK	8	ALU DARK	18x30		
3,0x3,0		15	0,11	50	-	ALU DARK	8	ALU DARK	18x30		
2,0x3,0		14	0,14	50	-	ALU DARK	6	ALU DARK	18x30		
3,0x4,0		18	0,12	50	-	ALU DARK	8	ALU DARK	18x30		

		COLOUR RANGE - ACRYL 350 GR									
		A1	A1	T2	T3	T6	T7	T8	T9	S1	
3,5		-					-	-	-		
3,0x3,0											
2,0x3,0											
3,0x4,0											



## descrizione /description

- la praticità della soluzione a braccio laterale interamente in acciaio e alluminio verniciato antracite mantiene il design raffinato inalterato nel tempo
  - base metallica a croce compresa nel prezzo, zavorre escluse
  - canaline con velcro su richiesta
  - ombrellone a braccio laterale
  - telaio in alluminio e componenti in acciaio
  - verniciato a polveri colore antracite
  - accessori in nylon
- handy cantilever parasol entirely made of epoxy lacquered steel and aluminium, keeps its refined design unchanged
  - cross metal base included in the price
  - ballasts excluded
  - rain gutter with velcro on request
  - cantilever parasol
  - frame in powder coated aluminium anthracite grey
  - nylon accessories.

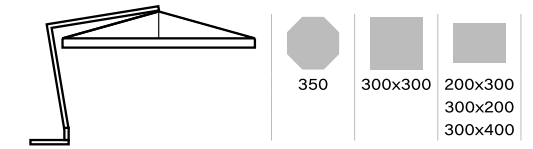

		CARATTERISTICHE			ACRYL 350 GR					BASES				
					A1S	A1N	T2S - T3S	T2N - T3N	T6N - T7N T8N - T9N S1N		N°2 BC5151 N°6 BC5050	N°4 BC5151 N°12 BC5050	N°2 BV5050	FISSAGGIO TERRA GROUND FIXING
	3,5	75x75	8	-	€ 2.280	-	€ 2.530	€ 2.530	€ 190					
	3,0x3,0	75x75	8	€ 2.335	€ 2.335	€ 2.590	-	€ 2.590	€ 190					
	2,0x3,0	75x75	6	€ 2.100	€ 2.335	-	-	-	€ 190					
		75x75	6	€ 2.100	€ 2.335	-	-	-	€ 190					
	3,0x4,0	75x75	8	€ 2.495	€ 2.495	€ 2.825	-	€ 2.825	€ 190					

MEASURES		CHARACTERISTICS						FINISHING											
↑	↓	KG	M <sup>2</sup>	75x75	ALU DARK	8	ALU DARK	18x30	●	●	360°	●	●	●	●	●	●	20°	●
3,5		50	0,20	75x75	ALU DARK	8	ALU DARK	18x30	●	●	●	●	●	●	●	●	●	●	●
3,0x3,0		50	0,20	75x75	ALU DARK	8	ALU DARK	18x30	●	●	●	●	●	●	●	●	●	●	●
2,0x3,0		48	0,20	75x75	ALU DARK	6	ALU DARK	18x30	●	●	●	●	●	●	●	●	●	●	●
3,0x2,0		48	0,20	75x75	ALU DARK	6	ALU DARK	18x30	●	-	●	●	●	●	●	●	●	●	●
3,0x4,0		52	0,21	75x75	ALU DARK	8	ALU DARK	18x30	●	●	●	●	●	●	●	●	●	●	●

		COLOUR RANGE - ACRYL 350 GR								
↑	↓	A1	A1	T2	T3	T6	T7	T8	T9	S1
3,5	-	-	A1N	T2N	T3N	T6N	-	-	-	S1N
3,0x3,0		A1S	A1N	T2S	T3S	T6N	T7N	T8N	T9N	S1N
2,0x3,0		A1S	A1N	-	-	-	-	-	-	-
3,0x2,0		A1S	A1N	-	-	-	-	-	-	-
3,0x4,0		A1S	A1N	T2S	T3S	T6N	T7N	T8N	T9N	S1N



# palladio s



## descrizione /description

- la linea classica, ma allo stesso tempo semplice ed essenziale lo rendono adatto a tutti gli ambienti e inattaccabile da tendenze di moda
- ampia gamma e varianti disponibili
- base non compresa nel prezzo
- canaline con velcro su richiesta
- telaio in legno iroko selezionato, trattato con vernice protettiva per esterni
- classic line, but at the same time simply and essential, unassailable by fashion trends. suitable for all environments
- wide range of sizes and variants
- base not included in the price
- rain gutter with velcro on request
- frame in selected iroko wood
- varnished and treated

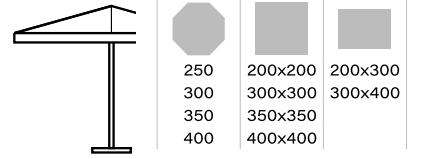

	CARATTERISTICHE			ACRYL 350 GR						BASES						
				A1S	A1N	T2S - T3S	T2N - T3N	T6N - T7N T8N - T9N S1N			BC35A4	BC55MA4	C80MA4	BF6565D BF6565Z	BF6666D BF6666Z	BUD8080
	2,5	38	6	-	€ 590	-	-	-	€ 105							
	2,5	48	6	-	€ 592	-	-	-	€ 105			/		/	-	
	3,0	48	8	-	€ 785	-	-	-	€ 105	/				/	-	
	3,5	48	8	-	€ 875	-	€ 1.120	€ 1.120	€ 130	/					-	
	4,0	58	8	-	€ 1.160	-	-	-	€ 130	/						
	2,0x2,0	48	4	€ 530	€ 530	-	-	-	€ 130			/		/	-	
	3,0x3,0	48	8	€ 930	€ 930	€ 1.185	-	€ 1.185	€ 130	/						
	3,5x3,5	58	8	€ 1.265	€ 1.265	€ 1.620	-	€ 1.620	€ 130	/						
	4,0x4,0	58	8	€ 1.415	€ 1.415	€ 1.825	-	€ 1.825	€ 130	/	/		/			
	2,0x3,0	48	6	€ 765	€ 765	-	-	-	€ 130	/				/	-	
	3,0x4,0	58	8	€ 1.145	€ 1.145	€ 1.470	-	€ 1.470	€ 130	/						

↕	COD	MEASURES		KG	📄	CHARACTERISTICS				📏	FINISHING				
		📐	📏			🌳	🏠	🌳	☀️		📏	🏠	🌳	☀️	
2,5	C2500 PAS			10	0,09	38 48	-	IROKO WOOD	6	IROKO WOOD	18x30	●	●	-	-
3,0	C3000 PAS			17	0,10	48	-	IROKO WOOD	8	IROKO WOOD	18x34	●	●	-	-
3,5	C3500 PAS			18	0,10	48	-	IROKO WOOD	8	IROKO WOOD	18x34	●	●	-	-
4,0	C4000 PAS			23	0,17	58	-	IROKO WOOD	8	IROKO WOOD	18x34	●	●	-	-
2,0x2,0	C2020 PAS			10	0,09	48	-	IROKO WOOD	4	IROKO WOOD	18x34	●	●	-	●
3,0x3,0	C3030 PAS			20	0,11	48	-	IROKO WOOD	8	IROKO WOOD	18x34	●	●	-	●
3,5x3,5	C3535 PAS			25	0,17	58	-	IROKO WOOD	8	IROKO WOOD	18x34	●	●	-	●
4,0x4,0	C4040 PAS			31	0,17	58	-	IROKO WOOD	8	IROKO WOOD	20x34	●	●	-	●
2,0x3,0	C2030 PAS			16	0,14	48	-	IROKO WOOD	6	IROKO WOOD	18x34	●	●	-	●
3,0x4,0	C3040 PAS			26	0,12	58	-	IROKO WOOD	8	IROKO WOOD	18x34	●	●	-	●

↕	COLOUR RANGE - ACRYL 350 GR									
	A1	A1	T2	T3	T6	T7	T8	T9	S1	
2,5	-		-	-	-	-	-	-	-	-
3,0	-		-	-	-	-	-	-	-	-
3,5	-					-	-	-	-	
4,0	-		-	-	-	-	-	-	-	-
2,0x2,0			-	-	-	-	-	-	-	-
3,0x3,0										
3,5x3,5										
4,0x4,0										
2,0x3,0			-	-	-	-	-	-	-	
3,0x4,0										



descrizione /description

- l'ombrellone vela ridefinisce il concetto e l'architettura dell'ombra, inedito e fuori dagli schemi. il design della copertura si evolve lasciandosi ispirare dal mare e sagomare dal vento, ottenendo linee sinuose ed ergonomiche. dalla fusione armonica tra un ombrellone e una vela nasce una sinergia tra resistenza dei materiali e leggerezza delle forme. un oggetto unico per valorizzare il vostro ambiente esterno.
  - base non compresa nel prezzo
  - telaio in alluminio con verniciatura a polveri colore inox
  - viteria in acciaio inox e componenti in nylon colore bianco
- the parasol vela redefines the concept and architecture of the shadow, unusual and unconventional. the cover design evolves taking inspiration from the sea and is shaped by the wind, resulting in sinuous and ergonomic lines. from the harmonic fusion between a parasol and a sail, a synergy between material strength and lightness of form, takes shape. a unique item to enhance your outdoor environment.
  - base not included in the price
  - aluminium inox coated frame
  - stainless steel screws and components in white nylon



	CARATTERISTICHE			ACRYL 350 GR						BASI						
				A1S	A1N	T2S - T3S	T2N - T3N	T6N - T7N			BC35A4	BC55 BC55MA4	BC80MA4	BF6565D BF6565Z	BF6666D BF6666Z	BUD8080
	2,0x2,0	40	4	-	-	-	-	€ 730	€ 105			/		/	/	
	3,0x3,0	50	4	-	-	-	-	€ 1.025	€ 130	/					/	

	MEASURES		CHARACTERISTICS						FINISHING		COLOUR RANGE ACRYL 350 GR	
			KG									
2,0x2,0			11	0,10	40	ALU INOX	4	ALU INOX	18x30			
3,0x3,0			14	0,10	50	ALU INOX	4	ALU INOX	18x35			



## descrizione /description

- ombrellone nato per soddisfare le esigenze di un prodotto compatto, ma robusto e pratico. può essere posizionato in molteplici location e ambienti. adatto ad un utilizzo nel settore balneare, piscine, balconi e terrazze
- base non compresa nel prezzo
- canaline con velcro su richiesta
- telaio in alluminio con verniciatura a polveri colore inox
- viteria in acciaio inox e componenti in nylon colore bianco

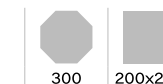
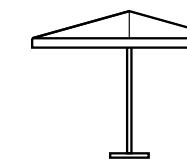

- parasol developed to meet the needs of a compact, robust and handy product. it can be placed in multiple locations and environments. suitable for use in bathing, pools, balconies and terraces
- base not included in the price
- rain gutter with velcro on request
- aluminium inox coated frame
- stainless steel screws and components in white nylon

CARATTERISTICHE			ACRYL 350 GR					BASI								
			A1S	A1N	T2S-T3S	T2N-T3N	T6N-T7N T8N-T9N S1N		BC35A4	BC55 BC55MA4	BC80MA4	BF6565D BF6565Z	BF6666D BF6666Z	BUD8080	BTT45+BTC BTT55+BTC	
○	3,0	50	8	€ 965	€ 965	-	-	-	€ 105			/		/	/	
□	2,0x2,0	40	4	€ 580	€ 580	-	-	-	€ 105			/		/	/	

MEASURES			CHARACTERISTICS					FINISHING		COLOUR RANGE ACRYL 350 GR	
			KG	M						A1	A1N
○	3,0		12	0,09	50	ALU INOX	8	ALU INOX	18x30		
□	2,0x2,0		10	0,09	40	ALU INOX	4	ALU INOX	18x30		



# cover



canalina-raingutter

# componenti e profili / components and profiles

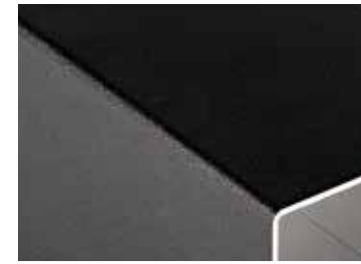

aluminium dark  
napoli s  
napoli b



iroko wood  
palladio s



aluminium star white  
napoli s  
napoli b



aluminium dark  
napoli s  
napoli b



alu inox  
napoli inox  
vela



aluminium star white  
napoli s  
napoli b

# kit led

cod	description	€	cod	description	€
kit led 50 w - c 3000 k	luce bianca - collegamento elettrico white light - for electric power connection weißes licht - strombedienung lumière blanc - connexion électrique luz blanca - conexión eléctrica	894	kit led 120 w - c 3000 k	luce bianca - collegamento elettrico white light - for electric power connection weißes licht - strombedienung lumière blanc - connexion électrique luz blanca - conexión eléctrica	1.752
kit led 50 w - b 3000 k	luce bianca - kit batteria white light - with battery weißes licht - batteriebedienung lumière blanc - avec la batterie luz blanca - kit de batería	1.120	kit led 120 w - b 3000 k	luce bianca - kit batteria white light - with battery weißes licht - batteriebedienung lumière blanc - avec la batterie luz blanca - kit de batería	1.942

## novità

- remote control
- luce dimmerabile
- attacco con clip calamitata

## new

- remote control
- dimmable light
- simplify fixing system with magnet

# astro timber alu wood



## descrizione /description

- connubio tra il futuro e il classico, adatto per tutti gli ambienti
  - telaio in alluminio con finitura legno
  - base metallica a croce compresa nel prezzo
  - zavorre escluse
  - canaline con velcro su richiesta
  - ombrellone a braccio retrattile con innovativa apertura e chiusura a molla a gas
- combination between the future and the classic, suitable for all environments
  - aluminium frame with wooden effect
  - cross metal base included in the price, ballasts excluded
  - rain gutter with velcro on request
  - innovating retractable cantilever parasol with opening and closing provided by gas spring

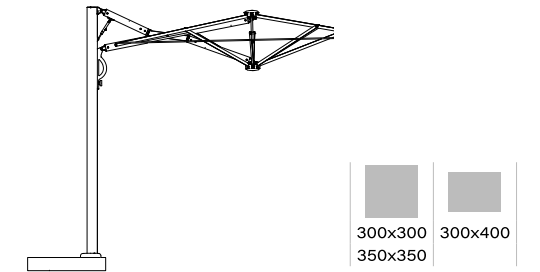

	CARATTERISTICHE			ACRYL 350 GR		N° 4 BC5151 N° 12 BC5050	BASI		FISSAGGIO TERRA GROUND FIXING
				A1N	T2N-T3N-T6N T7N-T8N-T9N S1N		N° 2 BV5050		
	3x3	110x76	8	€ 4.505	€ 4.705	€ 200			
	3,5x3,5	110x76	8	€ 4.965	€ 5.247	€ 200			
	3,0x4,0	110x76	8	€ 5.582	€ 5.098	€ 200			



# astro timber alu wood

## descrizione /description

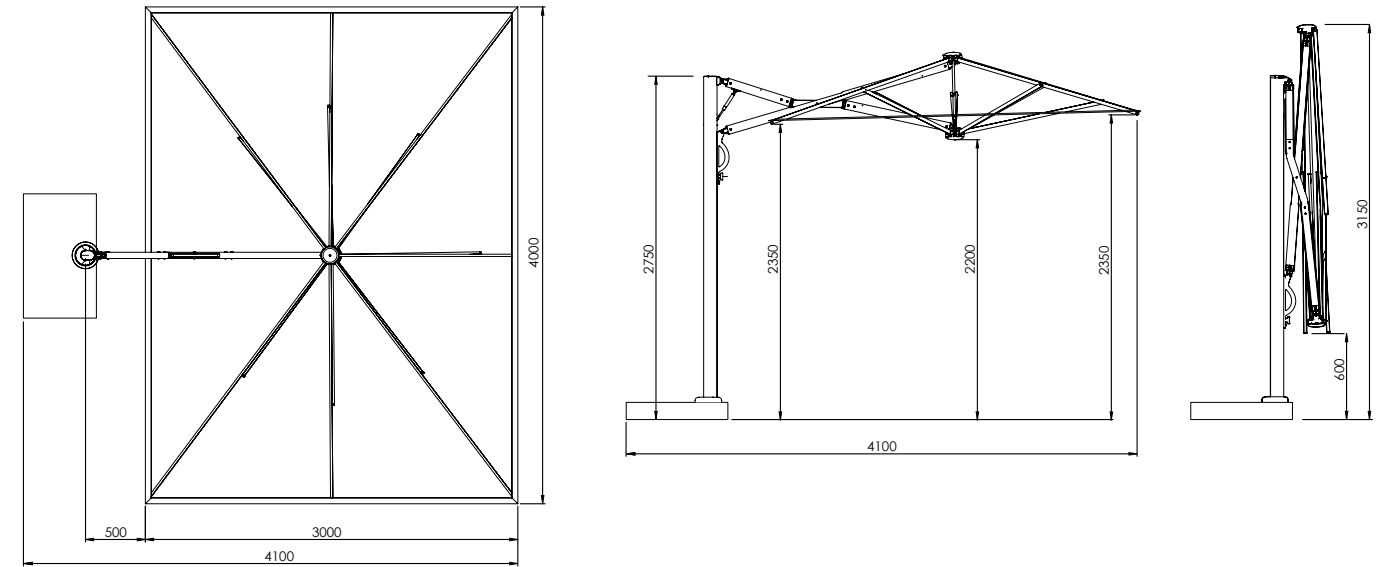
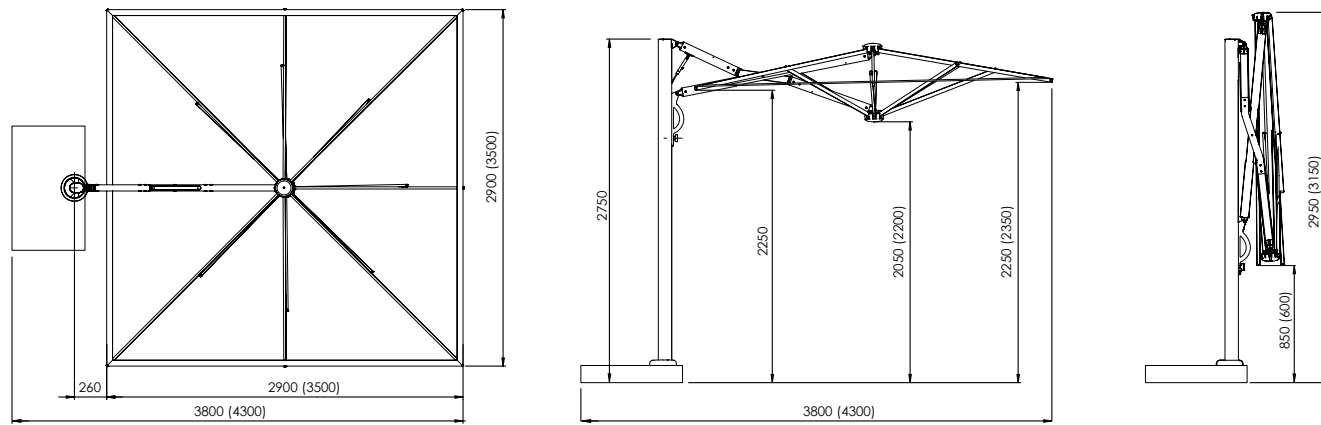

### CHARACTERISTICS

### FINISHING

3,0x3,0		55	0,45	110x76	alu wood	white	18x30	●	●	●	●	●	●
					carbon								
					titanium								
3,5x3,5		60	0,45	110x76	alu wood	white	18x30	●	●	●	●	●	●
					carbon								
					titanium								
3,0x4,0		60	0,45	110x76	alu wood	white	18x30	●	●	●	●	●	●
					carbon								
					titanium								

3,0x3,0		A1	T2	T3	T6	T7	T8	T9	S1
		A1N	T2N	T3N	T6N	T7N	T8N	T9N	S1N
3,5x3,5		A1	T2	T3	T6	T7	T8	T9	S1
		A1N	T2N	T3N	T6N	T7N	T8N	T9N	S1N
3,0x4,0		A1	T2	T3	T6	T7	T8	T9	S1
		A1N	T2N	T3N	T6N	T7N	T8N	T9N	S1N

# astro titanium



## descrizione /description

- adatto per tutti gli ambienti
- telaio in alluminio con finitura effetto titanium
- telaio in alluminio con effetto graffite carbon
- telaio in alluminio con finitura colore bianco opaco
- base metallica a croce compresa nel prezzo, zavorre escluse
- canaline con velcro su richiesta
- ombrellone a braccio retrattile con innovativa apertura e chiusura a molla a gas

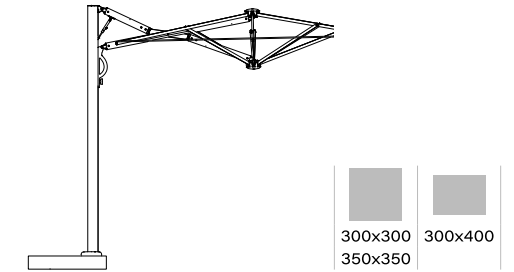

- suitable for all environments.
- aluminium frame with titanium effect
- aluminium frame with metallic carbon effect
- aluminium frame in colour matt starwhite
- cross metal base included in the price, ballasts excluded
- rain gutter with velcro on request
- innovating retractable cantilever parasol with opening and closing provided by gas spring

	CARATTERISTICHE			ACRYL 350 GR		€ 200	BASI		FISSAGGIO TERRA GROUND FIXING
	3x3	3,5x3,5	3,0x4,0	A1N	T2N - T3N - T6N T7N - T8N - T9N S1N		N° 4 BC5151 N° 12 BC5050	N° 2 BV5050	
	110x76	110x76	110x76	€ 4.352	€ 4.570				
	110x76	110x76	110x76	€ 4.860	€ 4.865				
	110x76	110x76	110x76	€ 4.690	€ 4.905				



# astro titanium

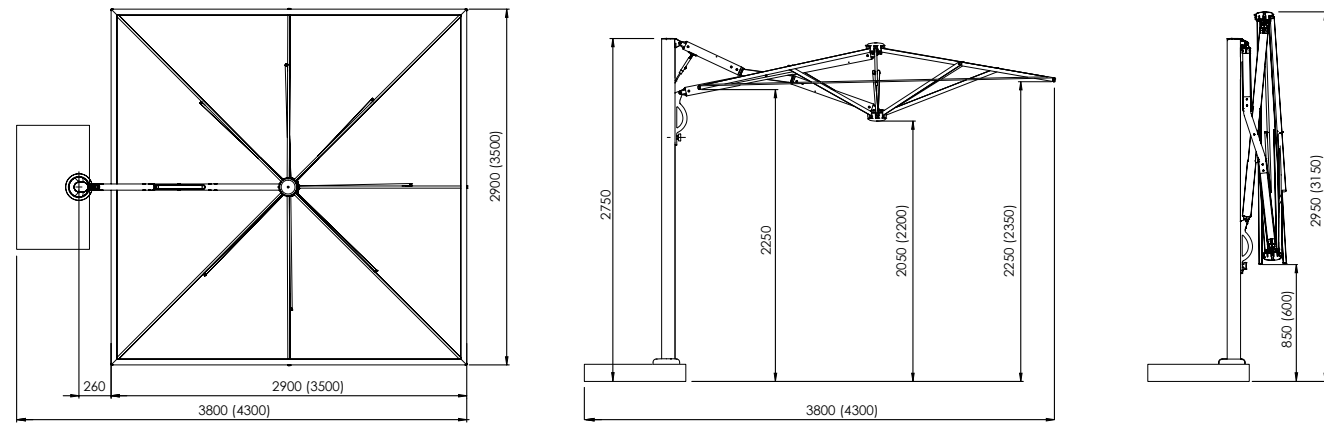

# descrizione /description

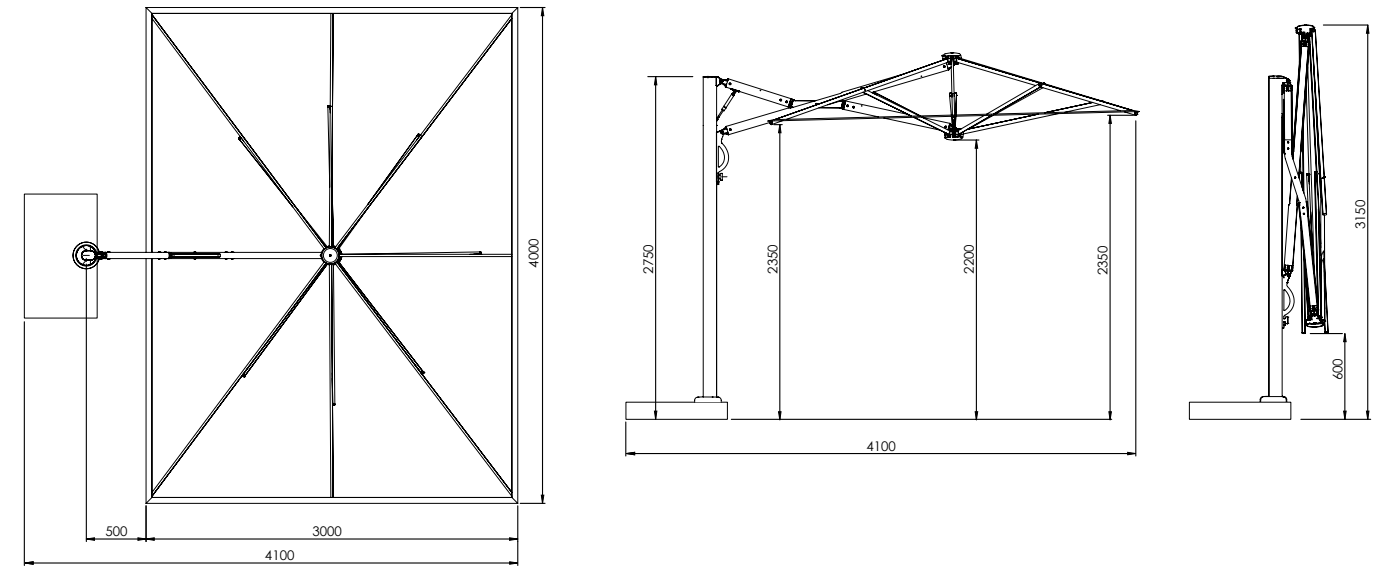

## CHARACTERISTICS

## FINISHING

↕	KG	MP	🏠	🌳	☀️	📐	📐	👤	360°	⚙️	🔩	🔩	📐	INOX
3,0x3,0	55	0,45	110x76	alu wood	8	alu wood	18x30	●	●	●	●	●	●	●
				white		white								
				carbon		carbon								
				titanium		titanium								
3,5x3,5	60	0,45	110x76	alu wood	8	alu wood	18x30	●	●	●	●	●	●	●
				white		white								
				carbon		carbon								
				titanium		titanium								
3,0x4,0	60	0,45	110x76	alu wood	8	alu wood	18x30	●	●	●	●	●	●	●
				white		white								
				carbon		carbon								
				titanium		titanium								

↕	A1	T2	T3	T6	T7	T8	T9	S1
3,0x3,0								
3,5x3,5								
3,0x4,0								

# componenti e profili / components and profiles

## componenti e profili alluminio aluminium components and profiles



alu wood



carbon



white



titanium

## profili stecche rib profiles



alu wood



carbon



white



titanium

## profili stecche rib profiles

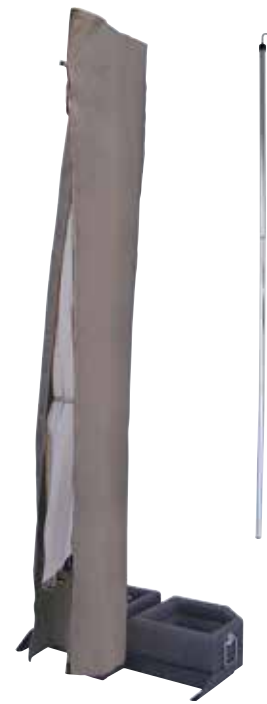

cover bag



canalina-raingutter

# kit led



descrizione/description		astro
- luce bianca - con collegamento elettrico	- remote control - luce dimmerabile	kit.led.gx.w.c. 3000k
- white light - electrical connection	- remote control - dimmable light	
		€ 990
- luce bianca - kit batteria	- remote control - luce dimmerabile	kit.led.gx.w.c. 3000k
- white light - battery kit	- remote control - dimmable light	
		€ 1.172

# basi standard telescopiche / standard telescopic bases



## bt45 - bt55 - bt65

tubo in acciaio zincato - doppio galletto - viteria inclusa  
steel zincated tube - double wing nut - screws included

	COD				KG	€
-	BT45	42 mm	45 mm	36 - 40 mm	1	35
	BT55	52 mm	55 mm	47 - 50 mm		35
	BT65	62 mm	65 mm	55 - 60 mm		35



## btt45 - btt55 - btt65

tubo acciaio per fissaggio a terra - eventualmente da abbinare all'articolo btc  
steel tube for ground fixing - possibility to combine it with art btc.

	COD				KG	€
-	BTT55	52 mm	55 mm	47 - 50 mm	1	52
	BTT65	62 mm	65 mm	55 - 60 mm		52



## btc

supporto da interrare - da abbinare a BTT55 e BTT65  
support for ground fixing - to combine with BTT55 and BTT65

	COD	KG	€
120x120x160 cm	BTC	1,5	100



## bf6565d - bf6666d

base in acciaio colore antracite - tubo incl.  
steel base colour antracite grey - tube incl.

	COD				KG	€
650x650x15 mm	BF6565D/T45	42 mm	45 mm	36 - 40 mm	35	420
	BF6565D/T55	52 mm	55 mm	47 - 50 mm	35	420
	BF6565D/T65	62 mm	65 mm	55 - 60 mm	35	420
650x650x25 mm	BF6666D/T45	42 mm	45 mm	36 - 40 mm	70	772
	BF6666D/T55	52 mm	55 mm	47 - 50 mm	70	772
	BF6666D/T65	62 mm	65 mm	55 - 60 mm	70	772



## bf6565z - bf6666z

base in acciaio zincato - tubo incl.  
zincated steel base - tube incl.

	COD				KG	€
650x650x15 mm	BF6565Z/T45	42 mm	45 mm	36 - 40 mm	35	387
	BF6565Z/T55	52 mm	55 mm	47 - 50 mm	35	387
	BF6565Z/T65	62 mm	65 mm	55 - 60 mm	35	387
650x650x25 mm	BF6666Z/T45	42 mm	45 mm	36 - 40 mm	70	723
	BF6666Z/T55	52 mm	55 mm	47 - 50 mm	70	723
	BF6666Z/T65	62 mm	65 mm	55 - 60 mm	70	723



## bud8080d - bud8080w

base a croce metallica verniciata dark o starwhite  
cross metal base epoxy coated dark or starwhite

	COD				KG	€
850x850 mm	BUD8080D/T55	52 mm	55 mm	47 - 50 mm	32	605
	BUD8080D/T65	62 mm	65 mm	55 - 60 mm	32	605
	BUD8080W/T55	52 mm	55 mm	47 - 50 mm	32	605
	BUD8080W/T65	62 mm	65 mm	55 - 60 mm	32	605



# basi / bases

# zavorre / ballast



## bc35a4

base in cemento graniglia - disponibile con tubo bt45, bt55, bt65 tubo incluso.  
cement grit base - available with tube bt45, bt55, bt65. tube incl.

	COD				KG	€
	BC35A4/T45	42 mm	45 mm	36 - 40 mm		117
Ø 540 mm	BC35A4/T55	52 mm	55 mm	47 - 50 mm	35	117
	BC35A4/T65	62 mm	65 mm	55 - 60 mm		117



## bc55ma4 - bc80ma4

base in cemento graniglia - disponibile con tubo bt45, bt55, bt65. tubo incluso  
cement grit base - available with tube bt45, bt55, bt65. tube incl.

	COD				KG	€
	BC55MA4/T45	42 mm	45 mm	36 - 40 mm		158
Ø 600 mm	BC55MA4/T55	52 mm	55 mm	47 - 50 mm	55	158
	BC55MA4/T65	62 mm	65 mm	55 - 60 mm		158
	BC80MA4/T45	42 mm	45 mm	36 - 40 mm		210
Ø 640 mm	BC80MA4/T55	52 mm	55 mm	47 - 50 mm	80	210
	BC80MA4/T65	62 mm	65 mm	55 - 60 mm		210



## bc5151gra4

piastra in cemento grigio con maniglie - disponibile con tubo bt45, bt55, bt65. tubo incluso.  
concrete grey cement slab with handles - available with tube bt45, bt55, bt65. tube incl.

	COD				KG	€
	BC5151GRA4/T45	42 mm	45 mm	36 - 40 mm		265
500 x 500 mm	BC5151GRA4/T55	52 mm	55 mm	47 - 50 mm	60	265
	BC5151GRA4/T65	62 mm	65 mm	55 - 60 mm		265

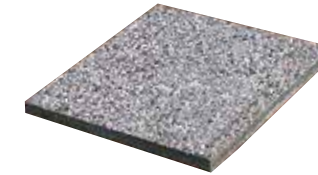

## bc4040 - bc5050

piastra in cemento e graniglia - spessore 4cm  
cement grit slab - thickness 4cm

	COD	KG	€
400x400 mm	BC4040	14	23
500x500 mm	BC5050	20	27



## bc5151

piastra in cemento e graniglia con maniglie - spessore 11cm. per ombrelloni a braccio  
cement grit slab with handles - thickness 11cm. for cantilever parasols

	COD	KG	€
500x500 mm	BC5151	60	135



## bc5151g

piastra in cemento grigio con maniglie - spessore 11cm. per ombrelloni a braccio  
concrete grey cement slab with handles - thickness 11cm. for cantilever parasols

	COD	KG	€
500x500 mm	BC5151G	60	135



## bv5050g

vaso in cemento grigio con maniglie - per ombrelloni a braccio  
concrete grey cement pot with handles - for cantilever parasols

	COD	H	KG	€
500x500 mm	BV5050G	270 mm	80	200



## bv5050b

vaso in cemento bianco con maniglie - per ombrelloni a braccio  
concrete white cement pot with handles - for cantilever parasols

	COD	H	KG	€
500x500 mm	BV5050B	270 mm	80	220





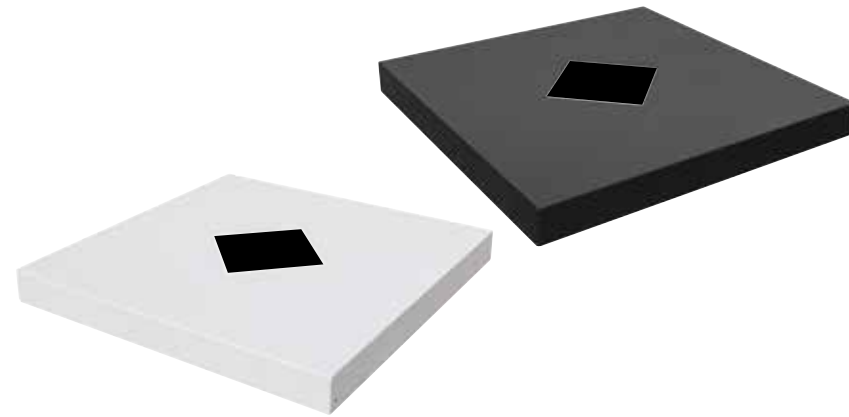

# optional base



## bdc8080





- carter acciaio zincato e verniciato a polveri
- colori disponibili dark-starwhite.
- compatibile con base bud8080.
- zined and epoxy coated steel carter
- available colors dark-starwhite
- suitable for base bud8080

				
870x870x12		BDC8080C	21	570
870x870x12		BDC8080W	21	570



## bud8080

- base a croce metallica opzionale per ombrellone a braccio
- da completare con 12 bc4040 (non comprese)
- optional cross metal base for cantilever parasols
- to be completed with 12 bc4040 (not included)

				
850 x 850		BUD8080C	32	570
		BUD8080W		570



## b8080r

- kit ruote alta resistenza girevoli e frenanti
- high resistance rotating and braking wheels kit

	
B8080R	437

# carter

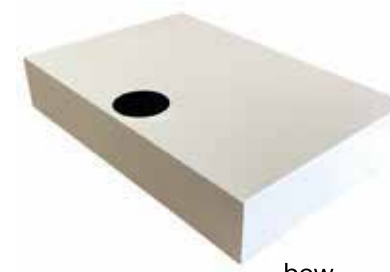



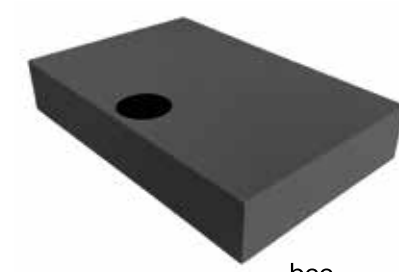

bcw



bcc

## bcc/bcw

- carter acciaio zincato e verniciato a polveri
- colori disponibili dark-starwhite.
- zined and epoxy coated steel carter
- available colors dark-starwhite

				
110x72x20		bcc	18	445
110x72x20		bcw	18	445





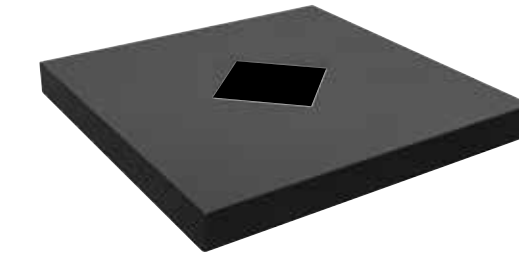

bdw



bdc

## bdc/bdw

- carter acciaio zincato e verniciato a polveri
- colori disponibili dark-starwhite.
- zined and epoxy coated steel carter
- available colors dark-starwhite

				
113x113x12		bdc	21	572
113x113x12		bdw	21	572

# tessuti / fabric

**a1s**  
 acrilico dralon 350gr trattato, impermeabilizzato teflon. antimuffa. colore ecru. con volant.

**a1n**  
 acrilico dralon 350gr trattato, impermeabilizzato teflon. antimuffa. colore ecru. senza volant.

**t2s**  
 acrilico dralon 350gr trattato, impermeabilizzato teflon. antimuffa. colore terracotta. con volant.

**t2n**  
 acrilico dralon 350gr trattato, impermeabilizzato teflon. antimuffa. colore terracotta. senza volant.

**t3s**  
 acrilico dralon 350gr trattato, impermeabilizzato teflon. antimuffa. colore bordeaux. con volant.

**t3n**  
 acrilico dralon 350gr trattato, impermeabilizzato teflon. antimuffa. colore bordeaux. senza volant.

**t6n**  
 acrilico dralon 350gr trattato, impermeabilizzato teflon. antimuffa. colore grigio taupe. senza volant.

**t7n**  
 acrilico dralon 350gr trattato, impermeabilizzato teflon. antimuffa. colore bianco. senza volant.

**t8n**  
 acrilico dralon 350gr trattato, impermeabilizzato teflon. antimuffa. colore grigio perla. senza volant.

**t9n**  
 acrilico dralon 350gr trattato, impermeabilizzato teflon. antimuffa. colore grigio antracite. senza volant.

**s1n**  
 acrilico dralon 350gr trattato, impermeabilizzato teflon. antimuffa. colore nero. senza volant.

**a1s**  
 acryl dralon 350gr waterproof treated teflon. anti mould. colour ecru. with valance

**a1n**  
 acryl dralon 350gr waterproof treated teflon. anti mould. colour ecru. without valance

**t2s**  
 acryl dralon 350gr waterproof treated teflon. anti mould. colour terracotta. with valance

**t2n**  
 acryl dralon 350gr waterproof treated teflon. anti mould. colour terracotta. without valance

**t3s**  
 acryl dralon 350gr waterproof treated teflon. anti mould. colour bordeaux. with valance

**t3n**  
 acryl dralon 350gr waterproof treated teflon. anti mould. colour bordeaux. without valance

**t6n**  
 acryl dralon 350gr waterproof treated teflon. anti mould. colour grey taupe. without valance

**t7n**  
 acryl dralon 350gr waterproof treated teflon. anti mould. colour white. without valance

**t8n**  
 acryl dralon 350gr waterproof treated teflon. anti mould. colour silver grey. without valance

**t9n**  
 acryl dralon 350gr waterproof treated teflon. anti mould. colour anthracit grey. without valance

**s1n**  
 acryl dralon 350gr waterproof treated teflon. anti mould. colour black. without valance



# tessuti speciali / special fabric

350gr/m² acrylic

gamma tessuti a richiesta  
 tessuto mano ombrellone.

fabric range on request  
 parasol fabric



	> 90%
	< 10%
	100%

i dati forniti, pur essendo frutto di misurazioni scientifiche condotte in laboratori certificati sono da ritenersi indicativi

the above mentioned data are indicative, although provided by scientific measurements performed in certified laboratories

# fabric collection



**fattore di protezione solare**  
 limita il passaggio del calore per più del 70%.  
 normativa uni en 410:2011

**solar protection factor**  
 harmful uv rays and limiting heat circulation  
 norm uni en 410:2011



**fattore di protezione luminosa**  
 indica la percentuale di trasmissione della  
 luce  
 normativa uni en 410:2011

**factor of solar light protection**  
 % of light transmission  
 norm uni en 410:2011



**fattore di protezione upf**  
 protezione dai raggi u.v. (upf) dal 85% al 100%  
 normativa uni en 13758-1:2007

**upf protection factor**  
 harmful uv rays. (upf) from 85% almost 100%  
 norm uni en 13758-1:2007

## scheda tecnica / data sheet

composizione / composition	caratteristiche / finishing	solidità al colore / color fastness	trattamento / treatment	impermeabilità / colonna d'acqua impermeability / water column
350 gr/m2 100% acryl	inattaccabile da muffe e batteri solido alla luce permeabile all'aria antimacchia	grado 7/8 ensio 105-b04	resine teflon idro-oleorepellenza	circa 25 cm
350 gr/m2 100% acryl	resistant to mold and bacteria color fast breathable stain repellent	grade 7/8 ensio 105-b04	teflon resin water-oilrepellency	about 25 cm



# legenda ombrelloni / sun umbrella



.dimensione (metri)  
 .dimensions (meters)



.set canaline  
 .raingutter set



.fodero  
 .cover bag



.viteria in inox e ottone nichelato  
 .screws in stainless steel and nickel



codice  
 code



con base/supporto  
 with base/support



doppia carrucola  
 double pulley



tipo finitura della struttura  
 sostegno/componenti  
 finishing for frame  
 structure/components



lunghezza  
 length



sezione stecche  
 rib section



sistema telescopico  
 telescopic system



colore dei componenti/stecche  
 component/ribs colour



peso  
 weight



camino antivento  
 wind cap



sistema retrattile  
 retractile system



stecca con sistema  
 "easy change"  
 ribs with  
 "easy change" system



volume (m3)  
 volume (m3)



volant  
 valance



base girevole a 360°  
 revolving base 360°



massima stabilità ottenibile  
 maximum obtainable stability



ø palo (mm)  
 ø pole (mm)



blocco antivento  
 wind stop



inclinazione fino a 20°  
 inclination up to 20°



peso consigliato  
 in condizioni normali  
 recommended weight  
 in normal condition



sezione sostegno (mm)  
 support section (mm)



con meccanismo  
 manovella  
 with winding  
 mechanism



inclinazione fino a 60°  
 inclination up to 60°



peso minimo richiesto  
 minimum ballast required



stecche  
 ribs



piastre cemento  
 cement slabs

# condizioni generali di vendita / general conditions of sale

## prezzi

i prezzi esposti nel seguente listino, si intendono iva e montaggio esclusi. non costituiscono offerta al pubblico e possono essere modificati in qualsiasi momento senza preavviso. le quotazioni sono strettamente legate alle caratteristiche tecniche, di misura, di colore e di tessuto dei relativi prodotti. eventuali richieste di prodotti fuori standard sono quotate separatamente.

## consegne

i termini di consegna hanno valore indicativo e non garantiscono il pieno rispetto dei tempi previsti, eccezione fatta per impegni esplicitamente espressi nell'ordinazione e confermati per iscritto.

per ordinazioni di grosse quantità i tempi di consegna saranno stabiliti di volta in volta e confermati alla data di accettazione dell'ordine. i termini concordati sono osservati dalla venditrice con la massima diligenza e possono venire prorogati per effetto di avvenimenti non ad essa imputabili o per causa di forza maggiore. le consegne mancate, ritardate e parziali non costituiscono un diritto del cliente a penalità, a variazioni e ad annullamenti di ordini né alla sospensione dei pagamenti.

## trasporto

la merce è resa franco fabbrica. la merce viaggia a rischio e pericolo del committente a trasporto effettuato a porto franco. la merce deve essere controllata al momento della consegna. ogni reclamo riguardante la qualità o la quantità della merce spedita dovrà essere notificato per raccomandata entro e non oltre 2 giorni dal ricevimento della stessa. trascorso tale termine non saranno ammessi reclami di sorta e le fatture si intenderanno integralmente accettate.

## imballo

i prezzi indicati sono comprensivi di imballo standard. i materiali verranno imballati nella forma più idonea e consona al trasporto pertanto potranno essere talvolta consegnati smontati. imballi diversi dallo standard o forniture di oggetti montati, dovranno essere concordati di volta in volta previa accettazione della ditta venditrice e conseguente aggiornamento del prezzo.

## garanzia

la durata della garanzia è 12 mesi (dodici) dalla data di consegna.

## pagamenti

da concordare prima della firma del contratto commerciale. minimo ordine € 1.000 netti. tutti i prezzi si intendono iva esclusa.

## montaggio

non è incluso nel prezzo. l'ufficio tecnico è a disposizione della clientela per fornire informazioni riguardo al montaggio e all'utilizzo dei propri prodotti.

## prices

this price list replaces all and any previous one. the prices exclude vat and installation. the prices cannot be considered as offer to the public and we reserve the right to vary them at any time, without prior notice. prices are strictly based to standard specifications (dimensions, materials, colours) of the relevant products. any request of non-standard product will be quoted separately.

## delivery time

the delivery date is indicative and cannot grant the lead time, except when clearly agreed and confirmed by written. for bigger quantities the delivery time will be agreed each time and confirmed in written on the order confirmation. the agreed delivery time will be respected by the selling company with extreme diligence. delayed or partial deliveries will never ever allow any penalty, order variation and/or cancellation not payments suspension.

## transport

the delivery term is ex factory. goods travel at buyer's risk in case of ddu delivery term. the merchandise has to be controlled at the delivery. any complaint regarding the quality and quantity of the goods has to be notified by written within 2 days from the receipt. complaints made after this time cannot be accepted and the invoice is considered entirely accepted.

## packaging

prices include standard wrapping. our items will be packed in the more suitable and convenient way for transport, consequently, sometimes, they may be delivered knocked down. special packaging or assembled items supplies can be agreed each time with prior approval of the selling company and with price surcharge.

## product warranty

duration of the warranty, is 12 (twelve) months from the date of delivery.

## payments

to be agreed before signing the commercial contract. minimum order € 1.000 net . all prices are excluding vat.

## assemble

not included in the price. the technical office is available to customers to provide information regarding the assembly and use of its products.

loun-  
ge  
sca-  
pe

## price list 2022



MC-Design  
Produktion- und Handelsgesellschaft mbH



Landsturmstraße 11  
5020 Salzburg

+43/(0)662/89 00 72  
+43/(0)662/89 00 72 15

office@mcd-hotelbedarf.com  
www.hotelshop.at